

PEARSON  
**Mathematics**  
STUDENT BOOK | VICTORIA

8



AUTHORS



# Contents

<b>1</b>	<b>Number properties</b>	<b>1</b>	<b>4</b>	<b>Percentage increase and decrease</b>	<b>81</b>
1.1	Establish and apply the exponent law for multiplication	3	4.1	Understand percentage increase and decrease	83
1.2	Establish and apply the exponent law for division	7	4.2	Understand percentage changes in realistic situations	90
1.3	Establish and apply the exponent law for raising a power to a power	12			
1.4	Establish and apply the exponent law for raising to the power of 0	16			
<b>2</b>	<b>Operations with integers, fractions and decimals</b>	<b>24</b>	<b>5</b>	<b>Algebra (expand, simplify and factorise)</b>	<b>103</b>
2.1	Multiply and divide integers	26	5.1	Use the distributive law to expand simple algebraic expressions	105
2.2	Solve problems by multiplying and dividing integers	31	5.2	Factorise simple algebraic expressions	108
2.3	Use the four operations with integers	37	5.3	Simplify algebraic expressions involving multiple operations	112
2.4	Multiply and divide rational numbers	43			
2.5	Apply all four operations with integers, fractions and decimals	48	<b>6</b>	<b>Linear graphs</b>	<b>122</b>
<b>3</b>	<b>Rational and irrational numbers</b>	<b>57</b>	6.1	Plot and identify a linear relationship using a set of points	124
3.1	Identify and use irrational numbers	59	6.2	Graph linear relationships with only one axis intercept	132
3.2	Identify the golden ratio and make the connection between the circumference	63	6.3	Investigate linear graphs using technology	139
3.3	Diameter of any circle	69	6.4	Determine the rule for a linear relationship or pattern	149
3.4	Identify and use terminating, recurring and non-recurring decimals	xx	6.5	Solve linear equations graphically	157
			<b>7</b>	<b>Linear inequalities</b>	<b>166</b>
			7.1	Graph inequalities on number lines	168
			7.2	Graph linear inequalities on the Cartesian plane	176
			7.3	Solve linear inequalities	188

# Contents

---

## **8 Perimeter and area 200**

- 8.1 Calculate the area of composite shapes 238
- 8.2 Approximate the perimeter and area of irregular shapes 244
- 8.3 Understand the connection between volume and capacity 258

---

## **9 Circles and sectors 278**

- 9.1 Determine the area of a circle 280
- 9.2 Determine the area of a sector using common fractions 285
- 9.3 Determine sector area and arc length 290
- 9.4 Determine the area of composite shapes involving circles 296
- 9.5 Solve problems involving circle measurements 301

---

## **10 Time 310**

- 10.1 Understand 24-hour time 312
- 10.2 Understand the effect of daylight savings and longitude on local time 320
- 10.3 Understand and work with different time zones 326

---

## **11 Rates 337**

- 11.1 Understand and apply rates 339
- 11.2 Apply rates to financial situations 343
- 11.3 Apply rates to tax calculations 348

---

## **12 Pythagoras' theorem in 2D 356**

- 12.1 Measure the side lengths of a right-angled triangle 358
- 12.2 Understand and use Pythagoras' theorem to identify right-angled triangles 364
- 12.3 Compare different applications, demonstrations and proofs of Pythagoras' theorem 373
- 12.4 Use Pythagoras' theorem to determine the length of the hypotenuse 381
- 12.5 Use Pythagoras' theorem to determine the length of a shorter side in a right-angled triangle 387

---

## **13 Ratios to solve problems 398**

- 13.1 Solve problems involving proportional reasoning 400
- 13.2 Apply ratios to currency exchange 406

---

## **14 Triangles and quadrilaterals (similarity and congruence) 415**

- 14.1 Apply transformations to shapes in the plane 417
- 14.2 Prove congruence in pairs of triangles 428
- 14.3 Explore the properties of quadrilaterals using congruent triangles 438
- 14.4 Determine and apply scale factor and angle properties in similar shapes 446
- 14.5 Prove similarity in pairs of triangles 455

# Contents

---

## **15 Visualising 3D 476**

- 15.1 Locate and describe the position of objects in 3D space 478
- 15.2 Use the 3D coordinate system 483

---

## **16 Collecting and analysing data 494**

- 16.1 Compare sampling methods 496
- 16.2 Understand sampling techniques and data sources 502
- 16.3 Understand and interpret statistics from different samples from the same population 514
- 16.4 Plan and conduct a statistical investigation 527

---

## **17 Probability (Venn diagrams and two-way tables) 545**

- 17.1 Understand complementary events 547
- 17.2 Draw and understand Venn diagrams 555
- 17.3 Draw and understand two-way tables 567
- 17.4 Recognise and understand mutually exclusive and non-mutually exclusive events 578
- 17.5 Use Venn diagrams and two-way tables to solve problems 588

COVER **Alamy**: Heycock, Amy, bridge; Simsek, Cigdem, atom; **Shutterstock**: Aliaksandr, Marko, satellite dish; Demater, drone; Flipser, speedometer; Retouch man, diamond.

# Circles and sectors

<b>Recall</b>	279
<b>9.1</b> Determine the area of a circle	280
<b>9.2</b> Determine the area of a sector using common fractions	285
<b>9.3</b> Determine sector area and arc length	289
<b>9.4</b> Determine the area of composite shapes involving circles	294
<b>9.5</b> Solve problems involving circle measurements	299
<b>Topic review</b>	304

## Why learn this?

Understanding how to determine the area of circles and sectors – portions of a circle bounded by radii from the centre and an arc lays the foundation for comprehending more complex geometric shapes and principles.

The skills covered here further refine spatial awareness by including areas bounded by arcs and circles, aiding to extend problem-solving skills that are applicable in various fields, such as engineering, architecture, horticulture and design.

# RECALL

I can identify features of a circle

- 1 Name the circle part represented by each label.

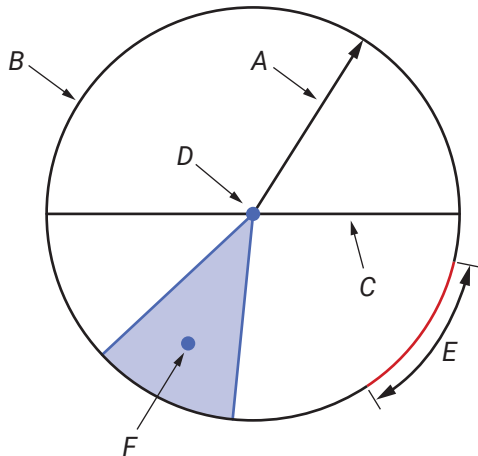

I can identify the size of special angles

- 1 Write the size of the angle described by the following names.

(a) right-angle                      (b) straight angle                      (c) revolution

I can simplify fractions

- 1 Write the following fractions in simplest form.

(a)  $\frac{30}{90}$                       (b)  $\frac{45}{120}$                       (c)  $\frac{52}{180}$                       (d)  $\frac{36}{270}$

I can write angles as a fraction of a revolution

- 1 Write the following angles as simplified fractions of a circle ( $360^\circ$ ).

(a)  $180^\circ$                       (b)  $90^\circ$                       (c)  $270^\circ$   
(d)  $45^\circ$                       (e)  $120^\circ$                       (f)  $60^\circ$

I can round decimals for different purposes

- 1 Round each of the following numbers to the number of decimal places stated in the brackets.

(a) 8.3625 (3)                      (b) 5.477 (2)                      (c) 2.193 (2)                      (d) 9.407 (2)  
(e) 94.82 (0)                      (f) 9.954 (1)                      (g) 5.981 (2)

I can round calculations to the required number of decimal places

- 1 Calculate each of the following, correct to 2 decimal places.

(a)  $3.14 \times 4$                       (b)  $(1.6)^2$                       (c)  $3.14 \times (1.5)^2$                       (d)  $3.142 \times (2.5)^2$

# 9.1

## Determine the area of a circle

**Learning intention:** To be able to determine the area of a circle

**Success criteria:**

**SC 1** I can establish the formula for the area of a circle using approximations

**SC 2** I can calculate the area of a circle

### Lesson warm-up

#### Area of a circle, using squares

Use a pair of compasses and 1 cm grid paper to draw a circle of radius 4 cm. By counting whole grid squares and approximating partial ones, estimate the area of the circle below, correct to the nearest square centimetre.

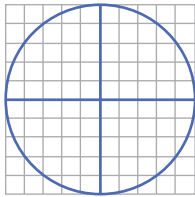

**SC 1** I can establish the formula for the area of a circle using approximations

The circumference of a circle of known radius or diameter can be calculated using  $\pi$  (pi).

$\pi$  is an irrational number, so it is not expressed as an exact decimal, but  $\pi \approx 3.14159$ .

The diameter is the distance from one edge of the circle to the opposite edge of the circle.

The radius is the distance from the centre to the edge of the circle.

The perimeter of a circle is called the circumference.

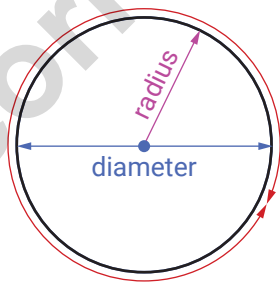

circumference

The circumference can be calculated using the formula

$$C = \pi d \text{ or } C = 2\pi r.$$

The area of a circle can also be calculated using  $\pi$ .

## Worked example

### Establishing the formula for the area of a circle from the circumference of a circle

Establish a formula for the area of a circle using the circumference formula  $C = 2\pi r$  and a circle divided into 12 equal sectors.

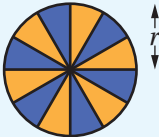
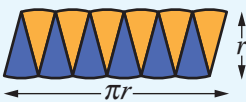
THINKING	WORKING
Divide a circle into twelfths.	
Cut out each segment and place half of them with curves placed along a line, and the other half inverted in the gaps.	
Describe the approximate shape.	The shape approximates a parallelogram.
Determine the dimensions, in terms of the radius, using the wavy length as the base. Note: the more sectors used, the more the shape becomes like a rectangle.	The base is the length of half the circumference. $b = \frac{2\pi r}{2}$ $= \pi r$ The height is the radius of the circle. $h = r$
Determine the area in terms of the radius.	$A = bh$ $= \pi r \times r$ $= \pi r^2$
Write the answer.	The area of a circle is $A = \pi r^2$ .

**SC 2** I can calculate the area of a circle

The formula for the area of a circle is  $A = \pi r^2$ .

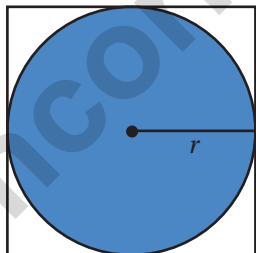

Since  $\pi$  is slightly more than 3, this means that a circle takes up a little more than  $\frac{3}{4}$  of the area of the square that contains it;  $\frac{\pi}{4}$  of the area of the square, to be exact.

## Worked example

### Calculating the area of a circle

Calculate the area of each circle, correct to 2 decimal places.

(a)

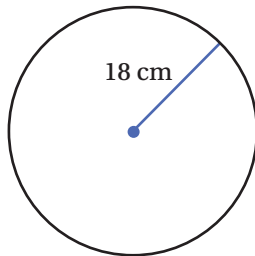

THINKING	WORKING
Identify the radius.	Radius: $r = 18$ cm
Recall the formula for the area of a circle.	$A = \pi r^2$
Substitute the value of $r$ into the formula and calculate the answer.	$A = \pi \times 18^2$ $= 1017.876 \dots$
Write the area using squared units.	The area is $1017.88 \text{ cm}^2$ (2 d.p.).

(b)

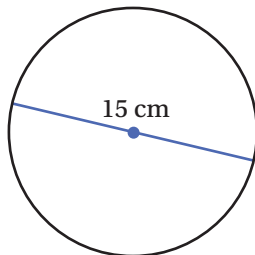

THINKING	WORKING
Identify the diameter.	Diameter: $d = 15$ cm
Determine the length of the radius.	Radius: $r = \frac{15}{2}$ $= 7.5$ cm
Recall the formula for the area of a circle.	$A = \pi r^2$
Substitute the value of $r$ into the formula and calculate the answer.	$A = \pi \times 7.5^2$ $= 176.714 \dots$
Write the area using squared units.	The area is $176.71 \text{ cm}^2$ (2 d.p.).

## Practice

### SC 1 I can establish the formula for the area of a circle using approximations

- 1 A circle is drawn on a grid of unit squares.

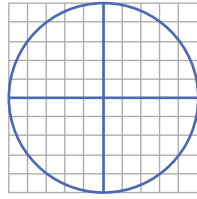

- Calculate the area of the entire grid in square units.
  - Calculate the area of one-quarter of the grid.
  - By counting whole grid squares and approximating with partial ones, estimate the area of the circle.
  - Describe how the area of the circle compares with the entire grid.
- 2 Establish a formula for the area of a circle using the circumference formula  $C = 2\pi r$  and a circle divided into eight equal sectors. Cut up and paste the sectors into your exercise book to accompany your work.
- 3 A circle with a circumference of 30 cm is divided into 10 equal sectors.
- What is the length of the arc of each sector?
  - What is the length of the radius, correct to 2 decimal places?
  - The sectors are arranged to form a parallelogram. Determine the area of the parallelogram, correct to 2 decimal places.

### SC 2 I can calculate the area of a circle

- 1 Calculate the area of each circle, correct to 2 decimal places.

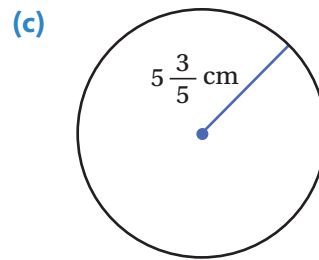
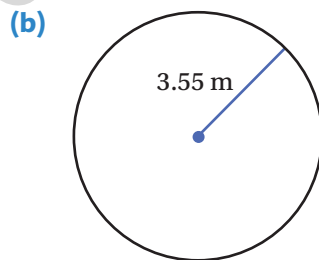
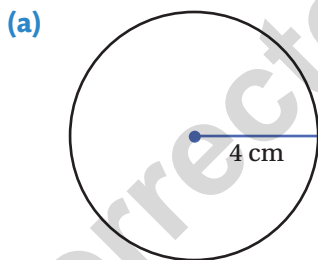

- 2 Calculate the area of each circle, correct to 2 decimal places.

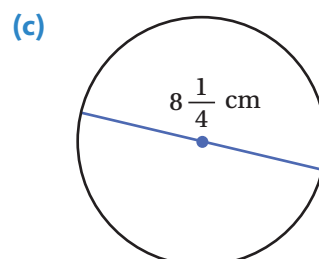
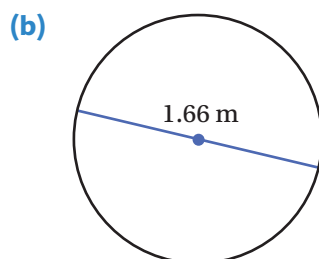
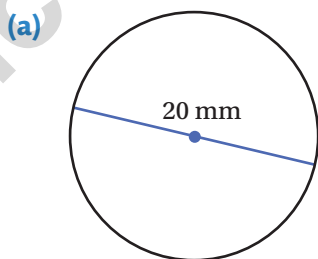

- 3 A circle of radius 7 cm is contained within a square. Answer the following questions, rounding answers to the nearest whole number, where necessary.

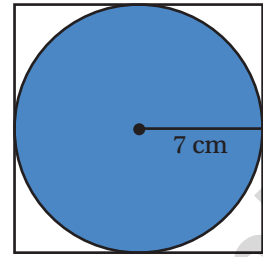

- (a) Determine each of the following.
- The perimeter of the square
  - The circumference of the circle
  - The area of the square
  - The area of the circle
- (b) The diagram is now doubled in size so that the radius is 14 cm. Determine each of the following for the new diagram.
- The perimeter of the square
  - The circumference of the circle
  - The area of the square
  - The area of the circle
- (c) Describe what happened to both perimeters after the radius was doubled.
- (d) Describe what happened to both areas after the radius was doubled.
- 4 An area in the shape of a circle, diameter 5 m, is to be covered with mosaic tiles.
- Calculate the area, rounded up to the nearest  $\text{m}^2$ .
  - Determine the cost of tiling the area, given that tiles cost  $\$85/\text{m}^2$ .
  - The border area is to be increased by 10 cm all the way around. What will be the increase in the cost? Round up the new area to the nearest  $\text{m}^2$  first.
- 5 Two circles have diameters of 6 cm and 10 cm, respectively.
- Calculate their circumferences to the nearest cm.
  - Compare the size of the circumferences.
  - Calculate the areas of the circles to the nearest  $\text{cm}^2$ .
  - Is there a similar increase in area from one circle to the next? Explain.
- 6 A circle of diameter 25 cm is drawn inside a circle of diameter 50 cm.

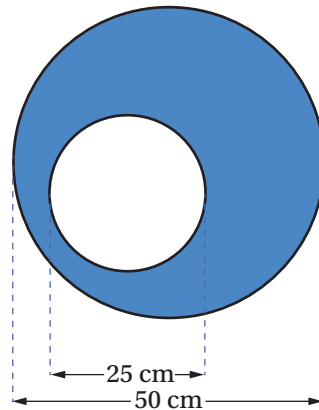

- Calculate the shaded area, to the nearest  $\text{cm}^2$ .
- Is the shaded area the same as the area of the smaller circle? Explain.

# Determine the area of a sector using common fractions

**Learning intention:** To be able to determine the area of a sector using common fractions

**Success criteria:**

**SC 1** I can determine the area of a sector using common fractions

## Lesson warm-up

### Parts of a circle

Copy and complete the table below showing the equivalent sector drawing, its central angle and fraction of a whole circle. The first one has been completed for you.

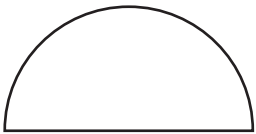
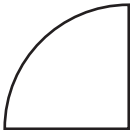
Sector	Angle	Fraction of a whole circle
	180°	$\frac{180}{360} = \frac{1}{2}$
		
	60°	
		$\frac{3}{4}$
	260°	



**SC 1** I can determine the area of a sector using common fractions

The area of any sector of a circle is a fraction of the area of a circle:  $A = \pi r^2$ .

Diagram	Properties
	<p>Name: Semicircle</p> <p>Fraction of circle: <math>\frac{180^\circ}{360^\circ} = \frac{1}{2}</math></p> <p>Area formula: <math>A = \pi r^2 \times \frac{1}{2} = \frac{\pi r^2}{2}</math></p>

Diagram	Properties
	Name: Quarter circle Fraction of circle: $\frac{90^\circ}{360^\circ} = \frac{1}{4}$ Area formula: $A = \pi r^2 \times \frac{1}{4} = \frac{\pi r^2}{4}$
	Description: Sector with $60^\circ$ angle at the centre Fraction of circle: $\frac{60^\circ}{360^\circ} = \frac{1}{6}$ Area formula: $A = \pi r^2 \times \frac{1}{6} = \frac{\pi r^2}{6}$

### Worked example

#### Determining the sector area using common fractions

Determine the area of the sector below. Round your answer correct to 1 decimal place.

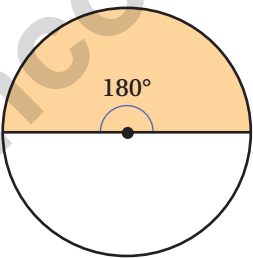
(a)

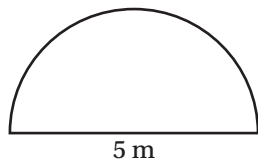

THINKING	WORKING
Determine the length of the radius.	$r = \frac{5}{2}$ $= 2.5 \text{ m}$
Recognise the fraction of a circle.	Semicircle: $\frac{1}{2}$ of a circle
Recall the formula for the area of a circle.	$A = \pi r^2$
Write a formula.	$A = \pi r^2 \times \frac{1}{2}$
Substitute the radius value.	$= \frac{\pi r^2}{2}$
Calculate the answer.	$= \frac{\pi \times 2.5^2}{2}$ $= 9.817\dots$
Write the answer.	The area of the sector is $9.8 \text{ m}^2$ (1 d.p.).

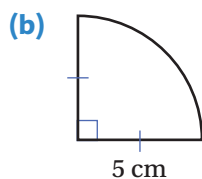

THINKING	WORKING
Identify the length of the radius.	$r = 5 \text{ cm}$
Recognise the fraction of a circle.	Quarter circle: $\frac{1}{4}$ of a circle
Recall the formula for the area of a circle.	$A = \pi r^2$
Write a formula.	$A = \frac{\pi r^2}{4}$
Substitute the radius value.	$= \frac{\pi \times 5^2}{4}$
Calculate the answer.	$= 19.6349\dots$
Write the answer.	The area of the sector is $19.6 \text{ cm}^2$ (1 d.p.).

### Worked example

#### Determining the sector area using an angle

Calculate the area of the sector below. Round your answer correct to 1 decimal place.

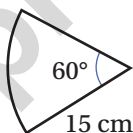

THINKING	WORKING
Identify the length of the radius.	$r = 15 \text{ cm}$
Determine the fraction of a circle.	$\frac{60^\circ}{360^\circ} = \frac{1}{6}$ of a circle
Recall the area of a circle.	$A = \pi r^2$
Write a formula.	$A = \frac{\pi r^2}{6}$
Substitute the radius value.	$= \frac{\pi \times 15^2}{6}$
Calculate the answer.	$= 117.809\dots$
Write the answer.	The area of the sector is $117.8 \text{ cm}^2$ (1 d.p.).

## Practice

### SC 1 I can determine the area of a sector using common fractions

1 A quarter circle is drawn on a grid of unit squares.

(a) By counting whole shaded squares and approximating with the partly shaded squares, estimate the area of the quarter circle to the nearest square unit.

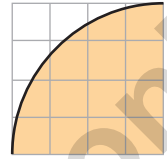

(b) Calculate the area as a quarter of the area of the circle using the formula. Round your answer correct to 1 decimal place.

2 Calculate the area of each sector below. Round your answers correct to 1 decimal place.

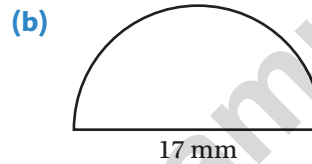
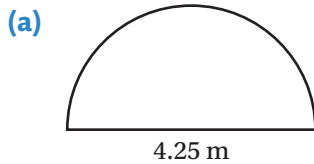

3 Calculate the area of a semicircle (half circle) correct to 2 decimal places, given the semicircle has a diameter of:

(a) 1 cm      (b) 2 cm      (c) 5 cm      (d) 10 cm      (e) 100 cm

4 Explain how to calculate the area of a semicircle.

5 Calculate the area of each sector below using a formula. Round your answers correct to 1 decimal place.

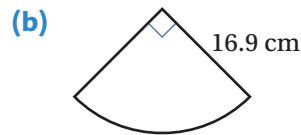
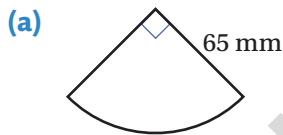

6 Calculate the area of a quarter circle correct to 2 decimal places, given the circle has a radius of:

(a) 1 cm      (b) 2 cm      (c) 5 cm      (d) 10 cm      (e) 100 cm

7 Explain how to calculate the area of a quarter circle.

8 Calculate the area of each sector below. Round your answers correct to 1 decimal place.

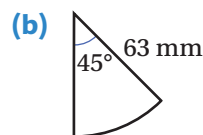
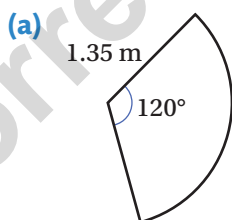

9 Calculate the area of the sectors taken from a circle with a radius of 5 cm. Write your answer correct to 2 decimal places.

(a) 36°      (b) 45°      (c) 60°      (d) 180°      (e) 270°

10 Explain how to calculate the area of a sector using an angle.

# Determine sector area and arc length

9.3

**Learning intention:** To be able to determine sector area and arc length

**Success criteria:**

**SC 1** I can determine the area of a sector with an angle of any size.

**SC 2** I can determine the arc length of a sector.

## Lesson warm-up

### Arc length and sectors

These two cars are turning at the same time and travelling at the same safe speed, changing direction from going straight to heading right. Explain what will happen during the turn and why.

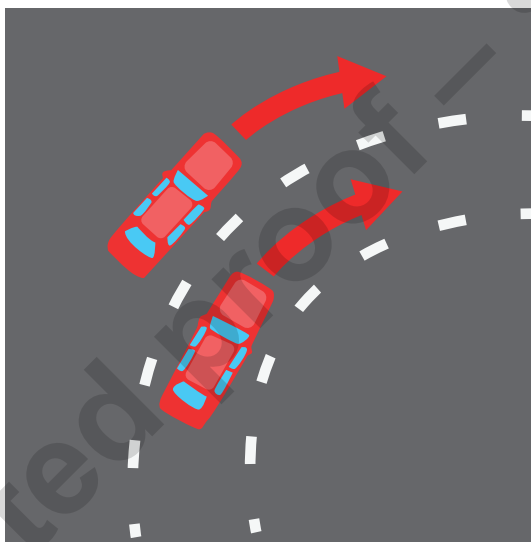

**SC 1** I can determine the area of a sector with an angle of any size

To determine the area of a sector with central angle  $90^\circ$ :

$\frac{90^\circ}{360^\circ} = \frac{1}{4}$ , so divide the area of the circle by 4. This is easier than multiplying by  $\frac{1}{4}$ .

For sectors of circles in which the angle at the centre is not a factor of  $360^\circ$ , it is not possible to divide the area of the circle by a whole number. Instead, the fraction of the circle is multiplied by the area of the circle.

To determine the area of a sector with central angle  $55^\circ$ :

$\frac{55^\circ}{360^\circ} = \frac{11}{72}$ , so multiply the area of the circle by  $\frac{11}{72}$ .

Formula for the area of a sector with radius  $r$  and central angle  $\theta$ .

$$A = \frac{\theta}{360} \times \pi r^2$$

## Worked example

### Area of a sector formula

Use the formula to calculate the area of the sector. Round your answer to 1 decimal place.

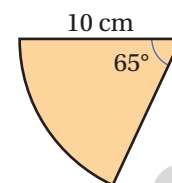

THINKING	WORKING
List the given information.	$r = 10 \text{ cm}, \theta = 65^\circ$
Recall the formula for the area of a sector.	$A = \frac{\theta}{360} \times \pi r^2$
Substitute the known values into the formula. Calculate the answer.	$A = \frac{65}{360} \times \pi \times (10)^2$ $= 56.7232 \dots$
Write the area, correctly rounded, in square units.	The area is $56.7 \text{ cm}^2$ (1 d.p.).

### SC 2 I can determine the arc length of a sector

The boundary, or perimeter, of a sector is made up of two radii and an arc that is a fraction of the circumference of a circle.

The formula for the perimeter of a sector with radius,  $r$  and central angle  $\theta$  is:

$$P = l + 2r, \text{ where } l = \frac{\theta}{360} \times 2\pi r = \frac{\pi r \theta}{180} \text{ is the arc length.}$$

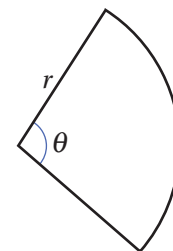

## Worked example

### Perimeter of a sector

For the sectors below, calculate the following, correct to 1 decimal place.

(i) arc length

(ii) perimeter.

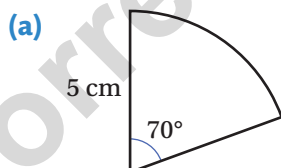

THINKING	WORKING
(i) List the given information.	Radius: $r = 5 \text{ cm}$ Central angle: $\theta = 70^\circ$
Recall the formula for arc length.	$l = \frac{\theta}{360} \times 2\pi r$

Substitute in the angle and radius values and calculate the arc length.	$l = \frac{70}{360} \times 2 \times \pi \times 5$ $= 6.10\dots$
Write the arc length, correctly rounded, and include units of length.	The arc length is 6.1 cm (1 d.p.).
<b>(ii)</b> Write the formula for perimeter. Substitute in the length and radius values. Calculate and show units of length.	$P = l + 2r$ $= 6.10\dots + 2 \times 5$ $= 16.1 \text{ cm (1 d.p.)}$
Write the perimeter, correctly rounded, and include units of length.	The perimeter is 16.1 cm (1 d.p.).

**(b)**

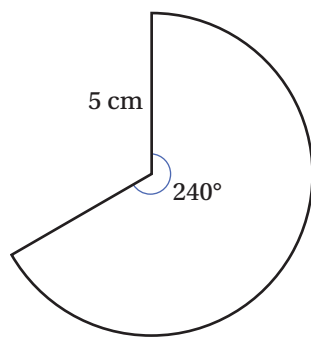

THINKING	WORKING
<b>(i)</b> List the given information.	Radius: $r = 5 \text{ cm}$ Central angle: $\theta = 240^\circ$
Recall the formula for arc length.	$l = \frac{\theta}{360} \times 2\pi r$
Substitute in the angle and radius values and calculate the arc length.	$l = \frac{240}{360} \times 2 \times \pi \times 5$ $= 20.94\dots$
Write the arc length, correctly rounded, and include units of length.	The arc length is 20.9 cm (1 d.p.).
<b>(ii)</b> Write the formula for perimeter. Substitute in the length and radius values. Calculate and show units of length.	$P = l + 2r$ $= 20.94\dots + 2 \times 5$ $= 30.9 \text{ cm (1 d.p.)}$
Write the perimeter, correctly rounded, and include units of length.	The perimeter is 30.9 cm (1 d.p.).

Determine sector area and arc length

**SC 1** I can determine the area of a sector with an angle of any size

1 Calculate the area of each sector below. Round your answers correct to 1 decimal place.

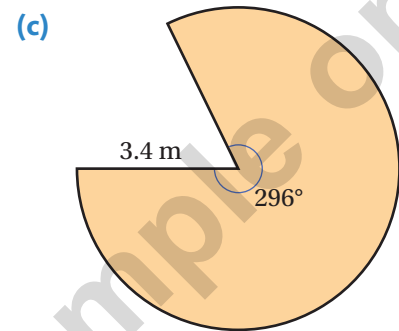
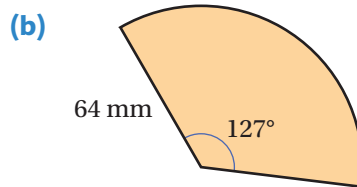
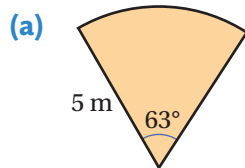

2 Calculate the area and perimeter of the sector below. Round your answers correct to 1 decimal place.

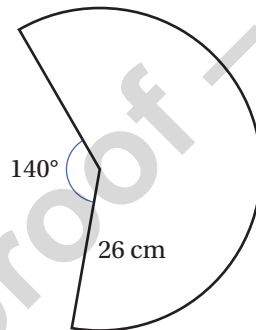

3 Calculate the area shaded in the shape, correct to 1 decimal place.

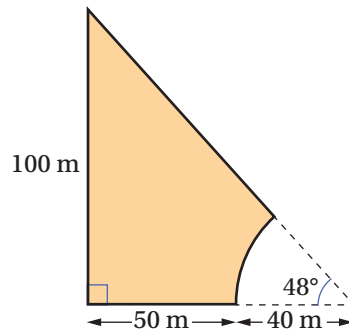

4 The hour hand of a clock is 5.5 cm long and the minute hand is 8.5 cm long. Write your answers to the nearest square centimetre.

(a) Calculate the area swept by the minute hand between 8.45 am and 9.05 am.

(b) Calculate the area swept by the hour hand between 9.05 am and 2.15 pm.

**SC 2** I can determine the arc length of a sector

1 For the sectors below, calculate the following, correct to 1 decimal place.

(i) arc length

(ii) perimeter.

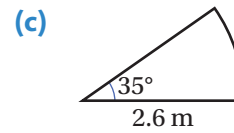
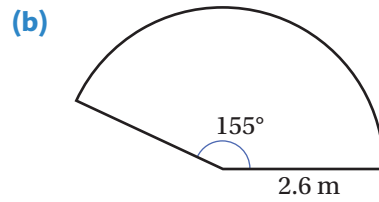
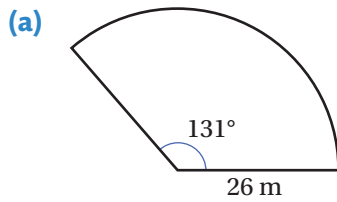

2 For the shape below, calculate the following, to the nearest whole number.

(a) arc length

(b) perimeter

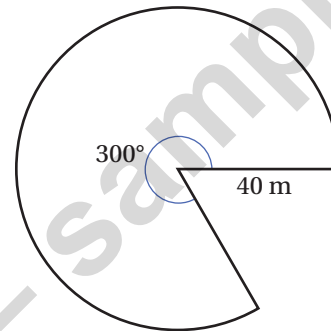

3 For the given sector, calculate:

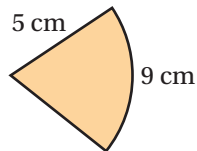

(a) the central angle, to the nearest degree

(b) the area, correct to 1 decimal place.

4 Calculate the area and perimeter of the shape below. Round your answers to 1 decimal place.

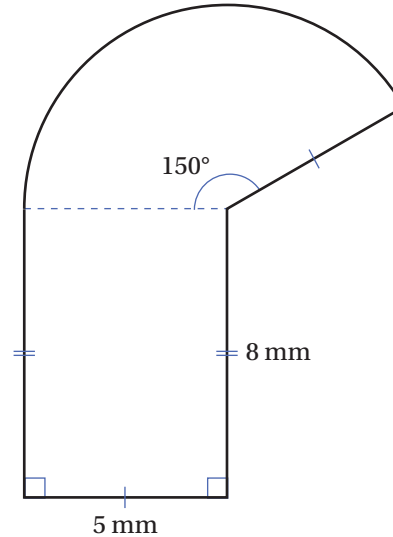

**Exploration Activity**

5 The following circle has a diameter of 10 cm.

(a) Calculate the perimeter of one of the pieces.

(b) Calculate the area of one of the pieces.

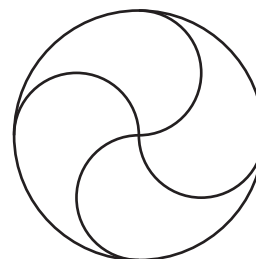

# 9.4

## Determine the area of composite shapes involving circles

**Learning intention:** To be able to determine the area of composite shapes involving circles

**Success criteria:**

**SC 1** I can determine the area of composite shapes involving circles

### Lesson warm-up

#### Composite shapes

The area of a rectangular piece of paper can be calculated by multiplying its length by the width.

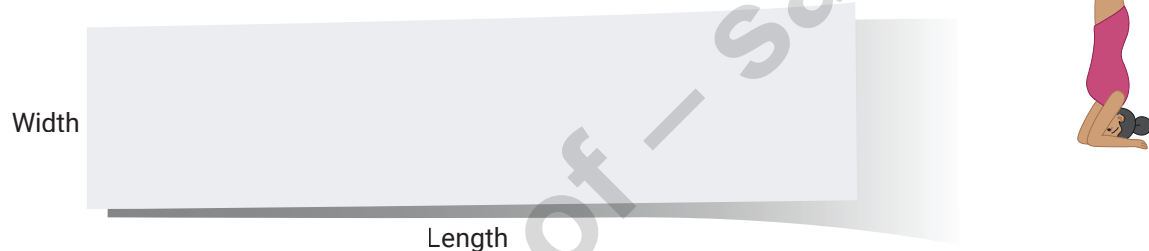

Fold the rectangular strip of paper as shown.

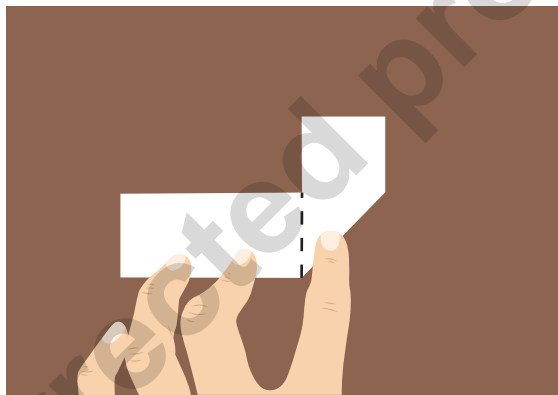

- 1 Has the area covered by the paper changed?
- 2 If so, has it increased or decreased?
- 3 Describe how the shape has changed.

**SC 1** I can determine the area of composite shapes involving circles

Calculating the area of odd shapes involves identifying standard shapes within the shape.

Determining the area of a composite shape involves adding together individual areas, but sometimes a shape removes an area, so subtraction is required as well.

## Worked example

### Composite areas involving circles

Calculate the area of each shape, correct to 1 decimal place.

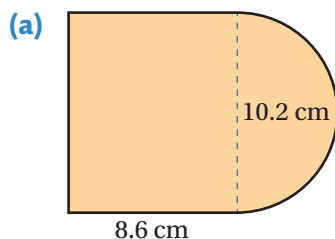

THINKING	WORKING
Describe the shapes to be used in the calculation, including the dimensions.	Rectangle: $l = 8.6$ cm, $w = 10.2$ cm Semicircle: $d = 10.2$ cm, so $r = 5.1$ cm
Write a formula for the calculation.	$A = lw + \frac{\pi r^2}{2}$
Substitute in the values for length, width, and radius. Calculate.	$A = 8.6 \times 10.2 + \frac{\pi \times (5.1)^2}{2}$ $= 128.57\dots$
Write the area, correctly rounded, in square units.	The area is $128.6 \text{ cm}^2$ (1 d.p.).

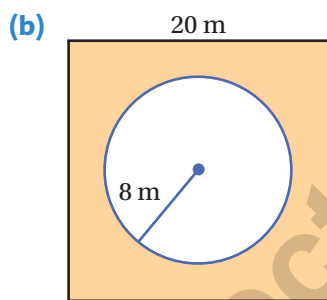

THINKING	WORKING
Describe the shapes to be used in the calculation, including the dimensions.	Square: $l = 20$ m Circle: $r = 8$ m
Write a formula for the calculation.	$A = l^2 - \pi r^2$
Substitute in the values for length and radius. Calculate.	$A = (20)^2 - \pi \times (8)^2$ $= 198.938\dots$
Write the area, correctly rounded, in square units.	The area is $198.9 \text{ m}^2$ (1 d.p.).

(c)

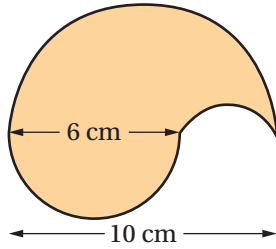

THINKING	WORKING
Describe the shapes to be used in the calculation, including the dimensions.	There are three semicircles that make up the diagram. Large semicircle: $d_1 = 10$ cm, so $r_1 = 5$ cm Medium semicircle: $d_2 = 6$ cm, so $r_2 = 3$ cm Small semicircle: $d_3 = 4$ cm so, $r_3 = 2$ cm
Write a formula for the calculation.	$A = \frac{\pi r_1^2}{2} + \frac{\pi r_2^2}{2} - \frac{\pi r_3^2}{2}$
Substitute in the radius values. Calculate.	$A = \frac{\pi r_1^2}{2} + \frac{\pi r_2^2}{2} - \frac{\pi r_3^2}{2}$ $= \frac{\pi \times (5)^2}{2} + \frac{\pi \times (3)^2}{2} - \frac{\pi \times (2)^2}{2}$ $= 47.12\dots$
Write the area, correctly rounded, in square units.	The area is $47.1 \text{ cm}^2$ (1 d.p.).

### Practice

ANSWERS Page XXX

**SC 1** I can determine the area of composite shapes involving circles

**1** Shapes involving circles have been drawn on grids of unit squares.

- (a) (i) By counting whole shaded squares and approximating with the partly shaded squares, estimate the area of each shape to the nearest square unit.
- (ii) Calculate the area of each shape by adding or subtracting individual areas. Round your final answers to 1 decimal place.

(b) (i)

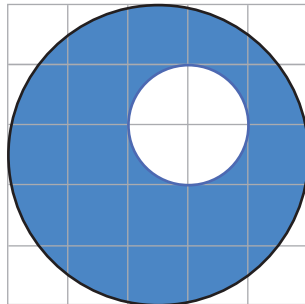

(ii)

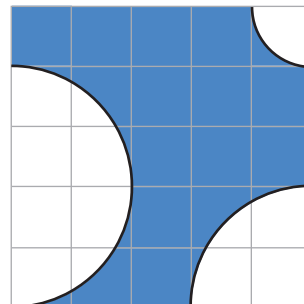

2 Calculate the area of each shape, correct to 1 decimal place.

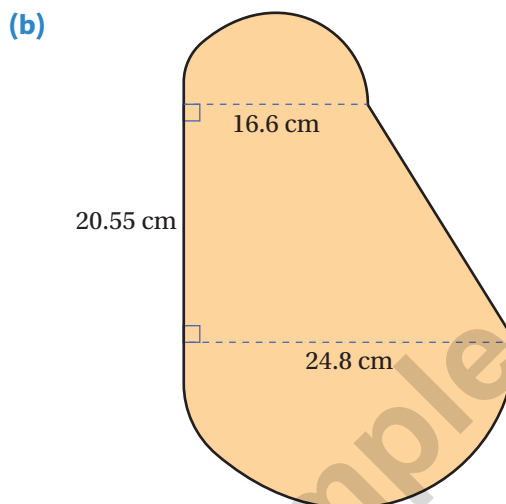
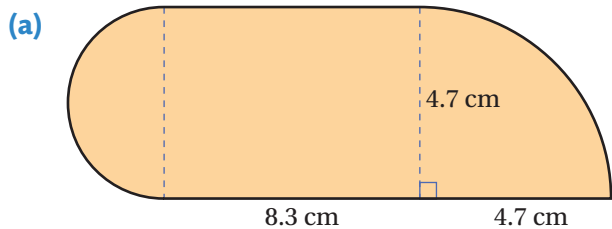

3 Calculate the shaded area of each shape, correct to 1 decimal place.

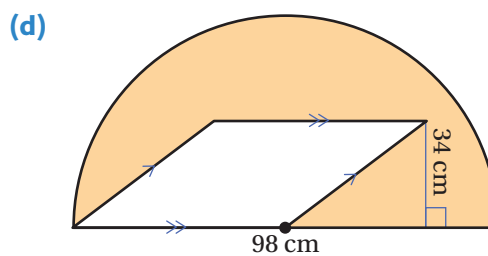
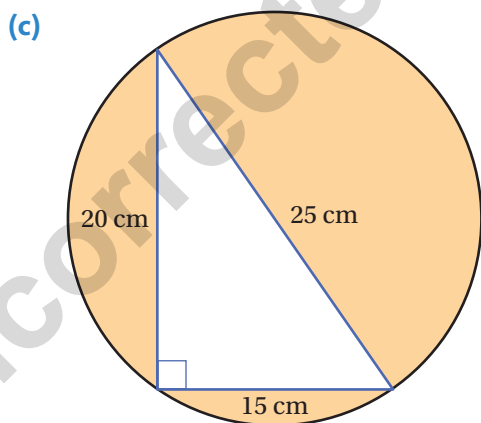
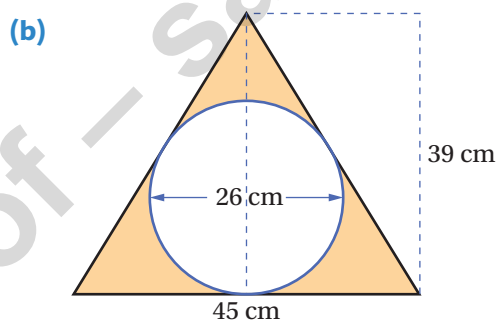
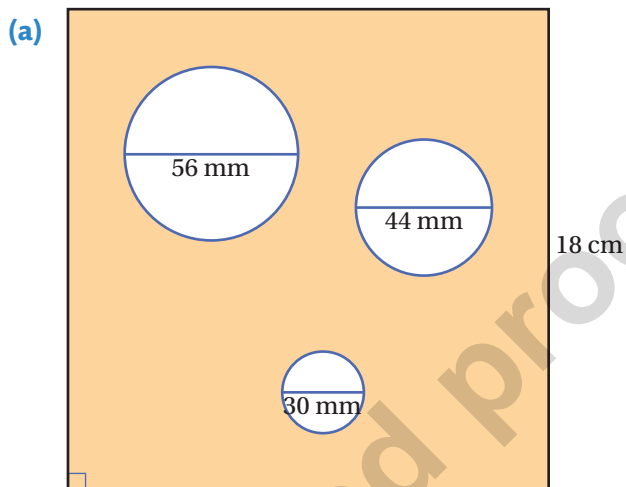

4 Calculate the area of each shape, correct to 1 decimal place.

(a)

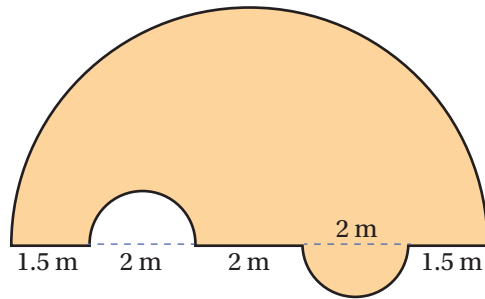

(b)

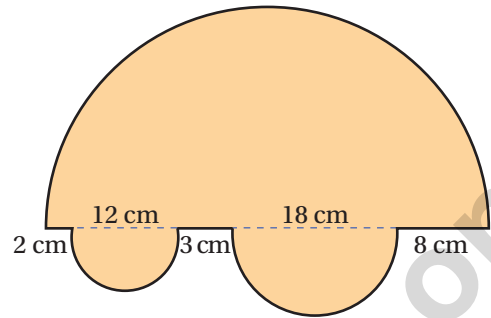

(c)

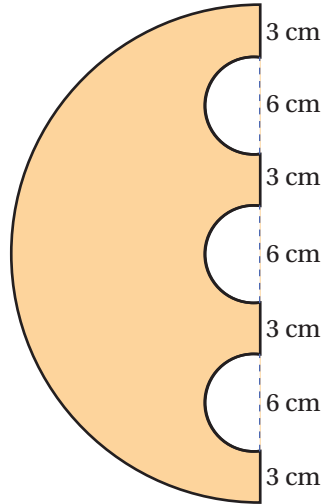

5 Calculate the area and perimeter of the shape, correct to 2 decimal places.

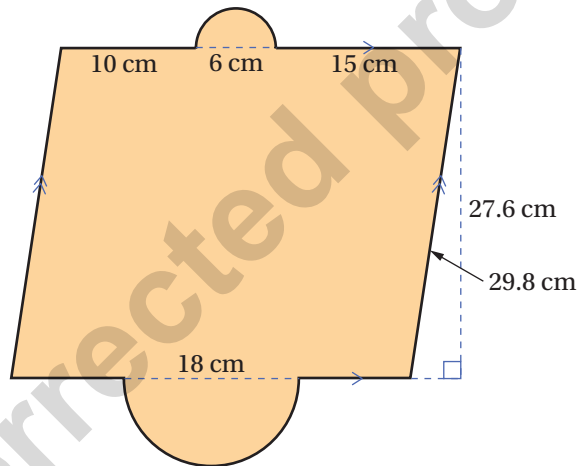

6 A rectangle is removed from a circle, as shown, with the remainder shaded.

The shaded area is between  $500 \text{ cm}^2$  and  $600 \text{ cm}^2$ .

(a) Given that the circle has a radius of 20 cm, determine possible dimensions for the rectangle.

(b) Given that the length of the rectangle is 20 cm, determine possible pairs of values for the width of the rectangle and the radius of the circle.

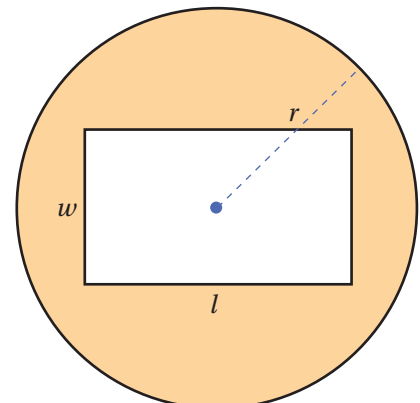

# Solve problems involving circle measurements

9.5

**Learning intention:** To be able to solve problems involving circle measurements

**Success criteria:**

**SC 1** I can solve practical problems involving circle measurements

## Lesson warm-up

### Bicycle wheels and circumference

Bike wheels come in different sizes. The size is measured by the height of the wheel (diameter). Using the wheel shown, find its circumference and then check your calculation by measuring the distance it covers after one full revolution.

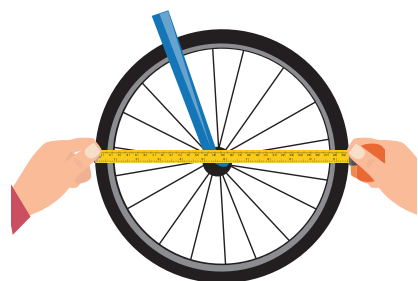

## EXPLORATION ACTIVITY

### The Penny Farthing Bike

One of the early bicycles in England was called the Penny Farthing. This was because the front and back wheels were different sizes and reminded people of two coins, a penny which was a coin slightly larger than a twenty cent piece and a farthing which was very small, close to the size of a 5 cent coin.

- 1 The larger wheel is 130 cm in diameter. How far does it travel in one revolution?
- 2 If the bike was ridden a distance of 1 km, how many turns of the wheel has there been?
- 3 The rear wheel is only 46 cm in diameter. How many turns has it made during the same 1 km trip?
- 4 Which tyre will wear out the fastest?
- 5 The pedals are situated on the large wheel. Why do you think this is this case?



**Worked example**

**Practical problems with circles**

Matt has a choice of buying a square rug of side length 244 cm, or a circular and semicircular rug, each with a diameter of 120 cm.

How much more area, to the nearest  $\text{cm}^2$ , does the square rug cover compared with the total area covered by the smaller rugs?

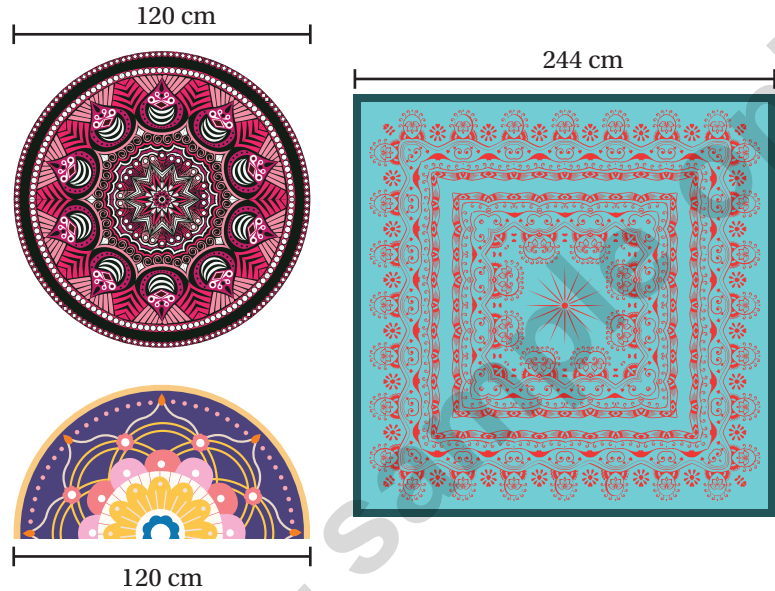

THINKING	WORKING
Write the task in terms of the shapes.	Difference in area: Area of square – areas of circle and semicircle
Identify the given information.	Square: $l = 244$ cm Circle and semicircle: $d = 120$ cm so, $r = 60$ cm
Recall the required area formulas.	Square: $A = l^2$ Circle: $A = \pi r^2$
Substitute in the values for length and radius. Calculate.	Square: $A = l^2$ $= 244^2$ $= 59\,536 \text{ cm}^2$ Circle and semicircle: $A = \pi r^2 + \frac{\pi r^2}{2}$ $= \pi \times 60^2 + \frac{\pi \times 60^2}{2}$ $= 16\,964.6 \dots \text{ cm}^2$
Calculate the difference.	$59\,536 - 16\,964.6 = 42\,571.4$
Write the answer.	The difference in area is approximately $42\,571 \text{ cm}^2$ (to the nearest square centimetre).

## Worked example

### Practical problem involving circumference

The radius of the Earth is 6400 km, to the nearest 100 km. Give all answers to the nearest 100 km.



- (a) Determine the distance around the Equator.

THINKING	WORKING
Identify the given information.	Radius of Earth: $r = 6400$ km
Write the task in terms of a circle.	Determine the circumference of Earth.
Recall the formula for the circumference.	$C = 2\pi r$
Determine the circumference by substituting in the value for radius.	$C = 2\pi r$ $= 2 \times \pi \times 6400$ $= 40\,212.3859 \dots$
Write the answer.	The distance around the equator is approximately 40 200 km (to the nearest 100 km).

- (b) Calculate the distance from the North Pole to the South Pole.

THINKING	WORKING
Write the task in terms of a circle.	Determine half of the circumference of Earth.
Write the formula.	$\frac{C}{2} = \frac{40\,212.3859 \dots}{2}$
Substitute the distance from part (a) and calculate.	$= 20\,106.1929 \dots$
Write the answer in words, correctly rounded to the nearest 100 km, with units of length.	The distance from the North Pole to the South Pole is approximately 20 100 km.

(c) How far would a ship travel going from 12°N to 15°S along the prime meridian?

THINKING	WORKING
Draw the situation.	
Write the task in terms of a circle.	Determine the arc length of a sector of central angle $12^\circ + 15^\circ = 27^\circ$ .
Recall the formula for arc length.	$l = \frac{\theta}{360} \times C$
Write the formula and substitute in the arc length and circumference values.	$l = \frac{27}{360} \times 40212.3859\dots$
Calculate.	$= 3015.9289\dots$
Write the answer in words, correctly rounded to the nearest 100 km, with units of length.	The distance from 15°S to 12°N is approximately 3000 km.

## Practice

ANSWERS Page XXX

**SC 1** I can solve practical problems involving circle measurements

- Determine the area, to the nearest  $\text{m}^2$ , of a model race track, 25 cm wide, whose inner shape is a rectangle 10 m by 8 m, with semicircles on each of the shorter sides.
- The dartboard has an inner circle of diameter 5 cm, with the rings 2.5 cm wide.

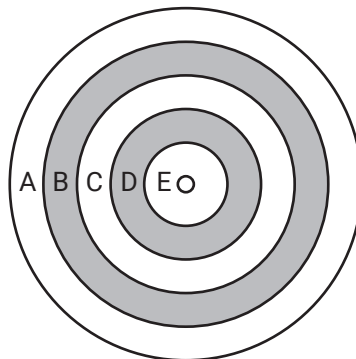

- Determine the total area of the shaded rings to the nearest  $\text{cm}^2$ .
- Describe the relationship between the area of the whole dartboard and:
  - $E$
  - the outermost ring (labelled  $A$ )

- 3 A flared skirt is to be made from panels as shown.

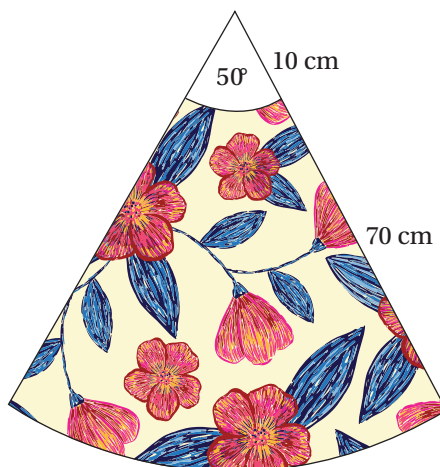

- (a) Calculate the area of fabric in each panel, to the nearest  $\text{cm}^2$ .  
 (b) Determine the perimeter of the panel, to the nearest cm.
- 4 The large back tyre of a tractor has a diameter of 108 cm, while the small front tyre has a diameter of 72 cm. Given that the tractor is moving at 12 km/h, how many more revolutions, to the nearest whole number, does the front tyre experience:
- (a) in 1 minute?                      (b) in 10 minutes?                      (c) in 2 hours?
- 5 The Wheel of Brisbane on South Bank is 60 m high.



Each ride completes 4 revolutions and costs \$15.75. How much does it cost to travel at least 10 km on the ride?

- 6 A shawl has a scalloped edge, a section of which is shown featuring 4 scallops. What length of edging is needed to trim the scallops, given that there are 80 scallops along the edge of the material? Round your answer to the nearest centimetre.

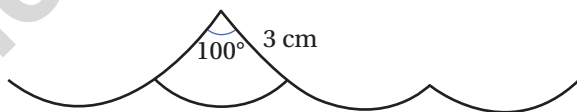

- 7 The radius of the Earth is approximately 6400 km. Aircraft travel at a height of 10 975 m. For an aircraft that travels halfway around the world, what is the extra distance travelled compared to the distance measured on the surface of Earth? Give your answer in kilometres, correct to 1 decimal place.

# TOPIC REVIEW

## Multiple choice

- The area of a circle with a diameter of 0.2 m is approximately:  
**A** 3140 cm<sup>2</sup>      **B** 3.14 cm<sup>2</sup>      **C** 314 cm<sup>2</sup>      **D** 31.4 cm<sup>2</sup>
- A circle with an area of 48 cm<sup>2</sup> has a radius correct to 2 decimal places, of:  
**A** 3.91 cm      **B** 5.53 cm      **C** 10.92 cm      **D** 12.28 cm
- What is the area of the semicircle below (correct to 2 decimal places)?

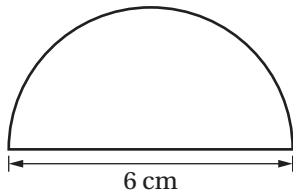

- A** 113.10 cm<sup>2</sup>      **B** 18.85 cm<sup>2</sup>      **C** 12.00 cm<sup>2</sup>      **D** 14.14 cm<sup>2</sup>
- The area in cm<sup>2</sup> of the shaded region is:

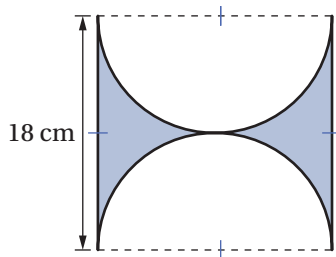

- A**  $18^2 - \pi \times 18^2$       **B**  $18^2 - \pi \times 9^2$       **C**  $18^2 + \pi \times 18^2$       **D**  $18^2 - \frac{1}{2} \times \pi \times 9^2$
- The perimeters of the shapes below, in order from smallest to largest, are:

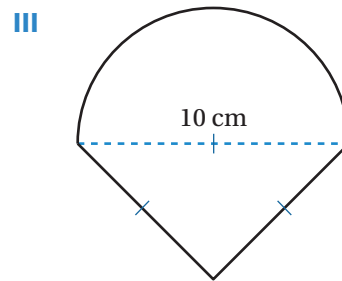
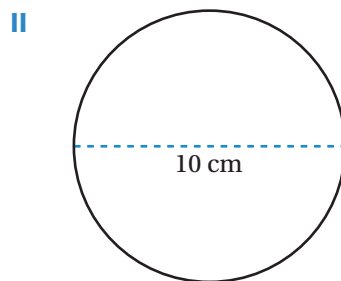
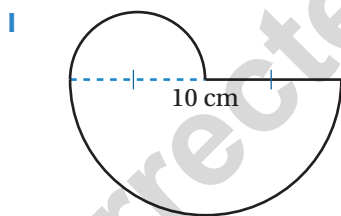

- A** II, I, III      **B** II, III, I      **C** I, III, II      **D** III, II, I

## Short answer

- 1 Write a unit fraction to approximate the portion of the total area that is shaded, so  $\frac{1}{2}$ ,  $\frac{1}{3}$ ,  $\frac{1}{4}$  etc.

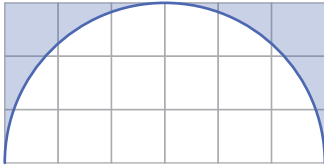

- 2 Calculate the area of each sector correct to 1 decimal place.

(a)

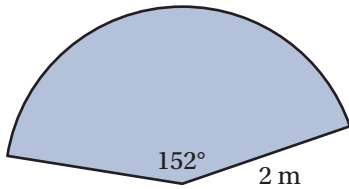

(b)

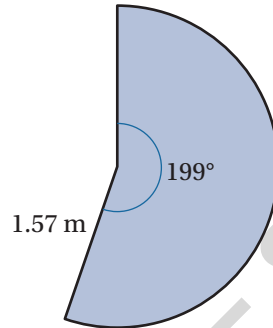

(c)



- 3 The area of the larger circle, centre O, is  $144 \text{ cm}^2$ . Determine the area shaded.

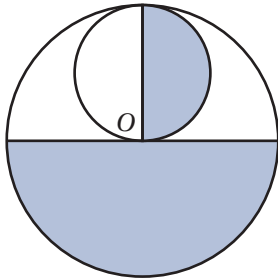

- 4 Calculate the area of the shape, correct to the nearest  $\text{m}^2$ .

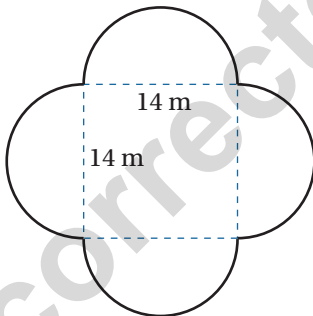

- 5 Calculate the area shaded, correct to 1 decimal place.

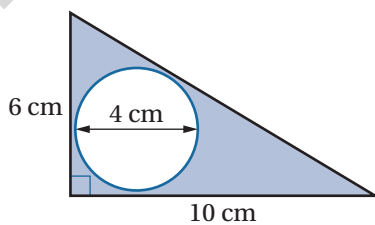

6 Calculate the perimeter of each shape, correct to the nearest whole number.

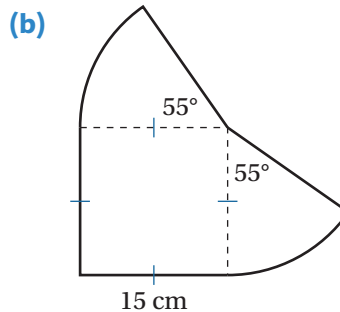
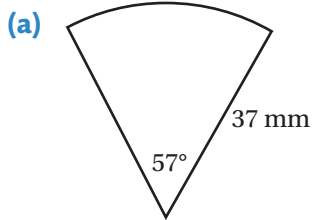

7 Calculate the perimeter and the area of each shape, correct to 2 decimal places.

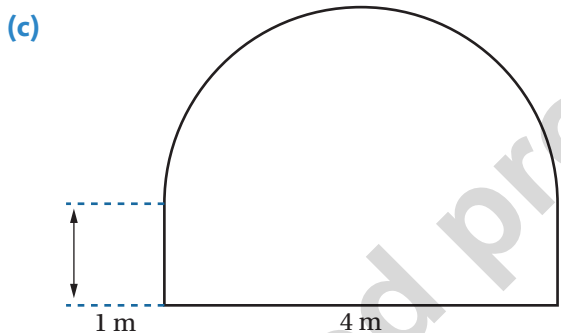
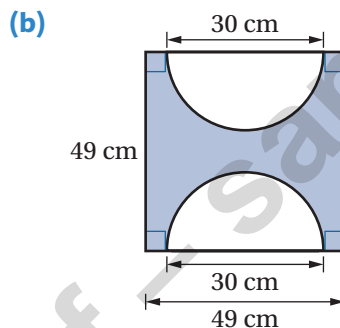
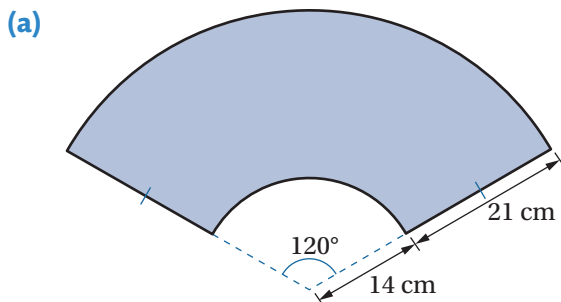

8 Calculate the area and perimeter of the shaded sector, correct to 1 decimal place.

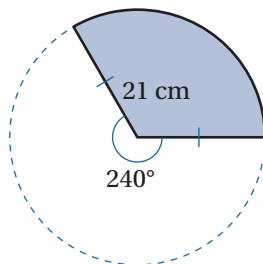

- 9 The dimensions on the shape below are given in centimetres.

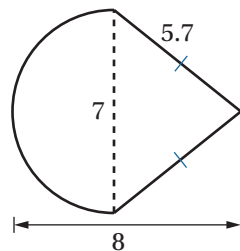

Determine the perimeter of the shape, correct to 1 decimal place.

- 10 Part of an awning is shaped as shown. Calculate the area of the given part, correct to 1 decimal place.

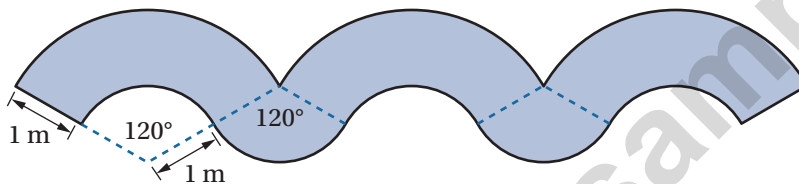

### Extended response

- 1 Tim has decided to retiling his backyard swimming pool, which has the dimensions outlined in the diagram below.

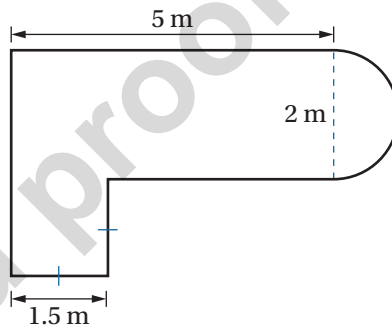

- Calculate the area of the base of the pool, rounded up to the nearest  $\text{m}^2$ .
- Determine the perimeter of the pool, correct to 2 decimal places.
- If the whole pool is 1.2 m deep, determine the area of the vertical surface around the pool, rounded up to the nearest  $\text{m}^2$ .
- If the tiles cost  $\$45$  per  $\text{m}^2$ , how much will they cost Tim for the internal area of the pool? (Base the cost on the rounded up areas.)

# Pearson Secondary Teaching Hub – Teaching program

## Victorian Curriculum v2.0

### Level 8

Pearson Secondary Teaching Hub mathematics lessons provide a systematic approach to deliver content in manageable chunks of content, defined by and written specifically to success criteria to ensure learning is relevant and purposeful.

## Curriculum coverage

Teaching Hub Level 8 topics	Strand	Vic Curric 2.0	Content description
Number properties (exponents)	Number	VC2M8N02	establish and apply the exponent laws with positive integer exponents and the zero-exponent, using exponent notation with numbers
Operations with integers, fractions and decimals	Number	VC2M8N04	use the 4 operations with integers and with rational numbers, choosing and using efficient mental and written strategies and digital tools where appropriate, and making estimations for these computations
Rational and irrational numbers	Number	VC2M8N01 VC2M8N03	recognise irrational numbers in applied contexts, including $\pi$ and numbers that develop from the square root of positive real numbers that are not perfect squares, and recognise that irrational numbers cannot develop from the division of integer values by natural numbers  convert between fractions and terminating or recurring decimals, using digital tools as appropriate
Percentage increase and decrease	Number	VC2M8N05 VC2M8N06	solve problems involving the use of percentages, including percentage increases and decreases and percentage error, with and without digital tools  use mathematical modelling to solve practical problems involving rational numbers and percentages, including financial contexts involving profit and loss; formulate problems, choosing efficient mental and written calculation strategies and using digital tools where appropriate; interpret and communicate solutions in terms of the context, reviewing the appropriateness of the model
Algebra (expand, simplify and factorise)	Algebra	VC2M8A01	create, expand, factorise, rearrange and simplify linear expressions, applying the associative, commutative, identity, distributive and inverse properties
Linear graphs	Algebra	VC2M8A02 VC2M8A03	graph linear relations on the Cartesian plane using digital tools where appropriate; solve linear equations and one-variable inequalities using graphical and algebraic techniques; verify solutions by substitution  use mathematical modelling to solve applied problems involving linear relations, including financial contexts involving profit and loss; formulate problems with linear functions, and choose a representation; interpret and communicate solutions in terms of the context, and review the appropriateness of the model
Linear inequalities	Algebra	VC2M8A02 VC2M8A03	graph linear relations on the Cartesian plane using digital tools where appropriate; solve linear equations and one-variable inequalities using graphical and algebraic techniques; verify solutions by substitution  use mathematical modelling to solve applied problems involving linear relations, including financial contexts involving profit and loss; formulate problems with linear functions, and choose a representation; interpret and communicate solutions in terms of the context, and review the appropriateness of the model

[Activity – coming soon]	Algebra	VC2M8A04 VC2M8A05	use algorithms and related testing procedures to identify and correct errors  experiment with linear functions and relations using digital tools, making and testing conjectures and generalising emerging patterns
Perimeter, area and volume	Measurement	VC2M8M01 VC2M8M02	solve problems involving the area and perimeter of irregular and composite shapes using appropriate units  solve problems involving the volume and capacity of right prisms using appropriate units
Circles and sectors	Measurement	VC2M8M03	solve problems involving the circumference and area of a circle using formulas and appropriate units
Time	Measurement	VC2M8M04	solve problems involving duration, including using 12- and 24-hour time across multiple time zones
Rates	Measurement	VC2M8M05	recognise and use rates to solve problems involving the comparison of 2 related quantities of different units of measure
Pythagoras theorem in 2 dimensions	Measurement	VC2M8M06	use Pythagoras' theorem to solve problems involving the side lengths of right-angled triangles
Ratios to solve problems	Measurement	VC2M8M07	use mathematical modelling to solve practical problems involving ratios and rates, including distance-time problems for travel at a constant speed and financial contexts; formulate problems; interpret and communicate solutions in terms of the situation, reviewing the appropriateness of the model
Triangles and quadrilaterals (similarity and congruence)	Space	VC2M8SP01 VC2M8SP02	identify the conditions for congruence and similarity of triangles and explain the conditions for other sets of common shapes to be congruent or similar, including those formed by transformations  establish properties of quadrilaterals using congruent triangles and angle properties, and solve related problems explaining reasoning
Visualising 3D	Space	VC2M8SP03	describe in different ways the position and location of three-dimensional objects in 3 dimensions, including using a three-dimensional Cartesian coordinate system with the use of dynamic geometry software or other digital tools
[Activity – coming soon]	Space	VC2M8SP04	Design and test algorithms involving a sequence of steps and decisions that identify congruency or similarity of shapes, and describe how the algorithm works
Collecting and analysing data	Statistics	VC2M8ST01 VC2M8ST02 VC2M8ST03	distinguish between a population and a sample, and investigate techniques for data collection including census, sampling, experiment and observation, and explain the practicalities and implications of obtaining data through these techniques  analyse and report on the distribution of data from primary and secondary sources using random and non-random sampling techniques to select and study samples  compare variations in distributions and proportions obtained from random samples of the same size drawn from a population and recognise the effect of sample size on this variation
[Activity – coming soon]	Statistics	VC2M8ST04	plan and conduct statistical investigations involving samples of a population; use ethical and fair methods to make inferences about the population and report findings, acknowledging uncertainty
Probability (Venn diagrams and two-way tables)	Probability	VC2M8P01 VC2M8P02	recognise that complementary events have a combined probability of one; use this relationship to calculate probabilities in applied contexts  determine all possible combinations for 2 events, using two-way tables, tree diagrams and Venn diagrams, and use these to determine probabilities of specific events in practical situations

[Activity – coming soon]	Probability	VC2M8P03	conduct repeated chance experiments and simulations, using digital tools to determine probabilities for compound events, and describe results
--------------------------	-------------	----------	---

The Victorian Curriculum F-10 content elements are © VCAA

## Year planner

Term	Pearson Secondary Teaching Hub topics
Term 1	Number properties (exponents) Operations with integers, fractions and decimals Rational and irrational numbers Percentage increase and decrease
Term 2	Algebra (expand, simplify and factorise) Linear graphs Linear inequalities Perimeter, area and volume
Term 3	Circles and sectors Time Rates Pythagoras theorem in 2 dimensions Ratios to solve problems
Term 4	Triangles and quadrilaterals (similarity and congruence) Visualising 3D Collecting and analysing data Probability (Venn diagrams and two-way tables)

# Features and support

## Phase: Activate prior knowledge

### Pearson Diagnostic

These quizzes are mapped to each topic and are designed to diagnose misconceptions and levels of understanding. Based on the results of these quizzes, each student receives personalised targeted activities to overcome misconceptions and upskill to ensure they are working at level for longer.

### Lesson warm-up

Every lesson begins with a lesson warm-up. This activity is designed to engage students in the lesson content and activate prior knowledge.

Every lesson warm-up comes complete with Teaching Notes (teacher view only), where teachers are supported with a suggested timeframe, any materials required, enabling and extending prompts and sample solutions.

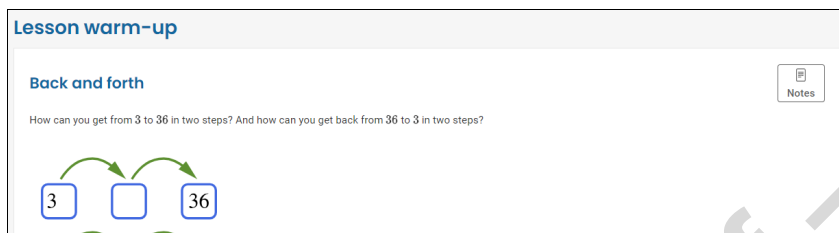

## Phase: Setting Learning Goals

The resources in Pearson Secondary Teaching Hub have been specifically created to support teachers and students.

The topics comprise lessons, the purpose of each lesson is defined by a learning intention and success criteria.

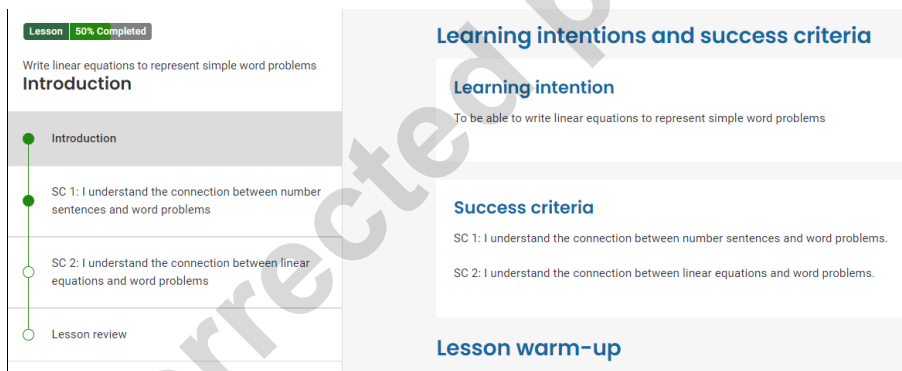

The hub gives access to Years 7 – 10 (Australian and Victorian curricula) and Stages 4 and 5 (NSW syllabus) content to ensure all students can access content at a suitable entry point and can be extended.

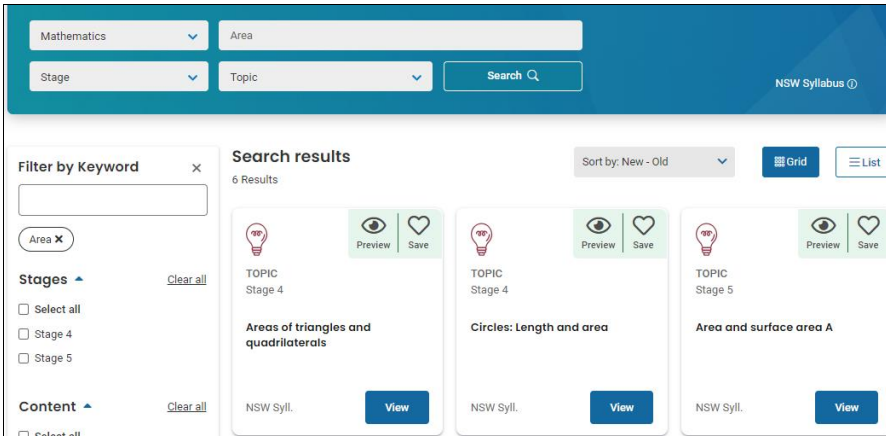

## Phase: Presentation (I do)

The demonstration phase of learning is supported with worked examples in the digital platform that are also presented as a video demonstration.

Success criteria have at least one worked example which is further supported with:

- a video walkthrough ‘See it as a video’
- a try yourself example in the Student Companion
- 1-3 autocorrecting ‘Check your understanding’ questions to assess student readiness to progress from guided practice to independent practice.

**Lesson** 50% Completed

Write linear equations to represent simple word problems

**SC 2: I understand the connection between linear equations and word problems**

- Introduction
- SC 1: I understand the connection between number sentences and word problems
- SC 2: I understand the connection between linear equations and word problems
- Lesson review

← Hide

### Writing an equation with an unknown in words

Worked example
See it as a video
Check your understanding

Write the equation  $x - 3 = 8$  in words.

Thinking	Working
Identify the operations in the equation.	The operation $-$ is subtraction. The symbol $=$ means ‘equals’.
Identify the unknown value or variable.	The unknown value or variable is $x$ .
List words that can be used to describe the operations and symbols.	subtract, difference, take away, less than, decrease equal, the same as
Write the equation using words.	Examples: Subtracting 3 from an unknown number $x$ is the same as 8. 3 less than an unknown number $x$ is equal to 8. The difference between an unknown number $x$ and 3 is 8.

## Phase: Guided Practice (We do)

Each of the digital lessons, contains approximately 1-2 corresponding pages in the Student Companion providing a place for guided practice. The ‘try yourself’ format of the worked example gives students the opportunity to practice the required skill or skills with the support of their teacher.

**Equations**

**Write linear equations to represent simple word problems**

**Learning intention:** To be able to write linear equations to represent simple word problems

**Success criteria:**

SC 1: I understand the connection between number sentences and word problems.

SC 2: I understand the connection between linear equations and word problems.

**SC 1: I understand the connection between number sentences and word problems**

**Worked example: Writing a number sentence using words**

Write  $10 - 4 = 6$  as a sentence using words.

Thinking	Working
Identify the operations or symbols used.	
List words that can be used to describe the operations and symbols.	
Write the sentence using words.	

**1** Write each number sentence using words.

(a)  $11 + 7 = 18$  \_\_\_\_\_

(b)  $18 - 7 = 11$  \_\_\_\_\_

(c)  $2 \times 9 = 18$  \_\_\_\_\_

(d)  $18 \div 2 = 9$  \_\_\_\_\_

**2** Write a list of words or phrases that can describe each operation or symbol.

+	-	×	÷	=
add				
sum				

## Phase: Independent Practice (You do)

Independent practice is supported in the digital lesson.

Each success criteria contains a ‘Practice’ section with approximately 4–6 exercise questions available in both the Student Book and in Hub.

**Practice**

Complete the following exercise questions in your notebook.

**1** Write each equation using words.

(a)  $x + 3 = 12$

(b)  $x - 3 = 12$

(c)  $3x = 12$

(d)  $\frac{x}{3} = 12$

**Answer**

**2** The equations  $3x + 2 = 12$  and  $3(x + 2) = 12$  have the same numbers and operations. Will the value of  $x$  be the same in both equations? Explain.

**Answer**

**3** Decide whether each pair of expressions are always equal, never equal or sometimes equal. Justify your answer with calculations.

(a)  $m + 3$  and  $3 + m$

(b)  $t - 3$  and  $3 - t$

(c)  $3 \times p$  and  $p \times 3$

(d)  $d \div 3$  and  $3 \div d$

**Answer**

**4** Write the following using only numerals and mathematical symbols.

(a) Multiply an unknown number  $n$  by 2 to give the answer 11.

(b) Add 7 to a number to give the answer 11.

COMING SOON

The teaching program will supply sample student navigation to support differentiation with a layered curriculum.



# Sample scope and sequence

## TERM 1

TOPIC 1: NUMBER PROPERTIES (EXPONENTS)			
<p><b>Content descriptions:</b></p> <p>VC2M8N02 establish and apply the exponent laws with positive integer exponents and the zero-exponent, using exponent notation with numbers</p> <p><i>The Victorian Curriculum F-10 content elements are © VCAA</i></p>			
<p><b>Pearson Diagnostic quizzes</b></p> <p><input type="checkbox"/> Meaning of multiplication <span style="margin-left: 200px;"><input type="checkbox"/> Prime, composite and square numbers</span></p> <p><input type="checkbox"/> Multiplication and division with 1 and 0 <span style="margin-left: 150px;"><input type="checkbox"/> Factors and multiples</span></p> <p><input type="checkbox"/> Multiplication and division by powers of 10</p>			
TERM 1: Weeks 1–3	Lesson name	Learning intention and success criteria	Differentiating independent practice
	Establish and apply the exponent law for multiplication	<p><b>Learning intention:</b> To establish and apply the exponent law for multiplication</p> <p><b>Success criteria:</b></p> <p>SC 1: I can write the expanded form of a multiplication from exponent form and connect the result to the addition of exponents.</p> <p>SC 2: I can multiply numbers using exponent notation.</p>	
	Establish and apply the exponent law for division	<p><b>Learning intention:</b> To establish and apply the exponent law for division</p> <p><b>Success criteria:</b></p> <p>SC 1: I can write the expanded form of a division from exponent form and connect the result to the subtraction of exponents.</p> <p>SC 2: I can divide numbers using exponent notation.</p> <p>SC 3: I can apply the multiplication and division rules, or a combination of both, to simplify an expression.</p>	
	Establish and apply the exponent law for raising a	<p><b>Learning intention:</b> To establish and apply the exponent law for raising a power to a power</p> <p><b>Success criteria:</b></p>	

	power to a power	<p>SC 1: I can use expanded form to simplify the power of a power.</p> <p>SC 2: I can use exponent laws to simplify a power of a power.</p> <p>SC 3: I can apply the exponent laws of multiplication, division and raising to a power.</p>		
	Establish and apply the exponent law for raising to the power of 0	<p><b>Learning intention:</b> To establish and apply the exponent law for raising to the power of 0</p> <p><b>Success criteria:</b></p> <p>SC 1: I can demonstrate that any natural number raised to the power of 0 is equal to 1.</p> <p>SC 2: I can simplify and evaluate expressions that require multiple exponent laws to be used.</p>		

Uncorrected proof – Sample only

## TOPIC 2: OPERATIONS WITH INTEGERS, FRACTIONS AND DECIMALS

**Content descriptions:**

VC2M8N04 use the 4 operations with integers and with rational numbers, choosing and using efficient mental and written strategies and digital tools where appropriate, and making estimations for these computations

*The Victorian Curriculum F-10 content elements are © VCAA*

**Pearson Diagnostic quizzes**

- |  |   |
|--|---|
| <input type="checkbox"/> Addition facts                | <input type="checkbox"/> Operations with integers       |
| <input type="checkbox"/> Subtraction facts             | <input type="checkbox"/> Fraction operations (concepts) |
| <input type="checkbox"/> Multiplication facts (tables) | <input type="checkbox"/> Fraction operations (skills)   |
| <input type="checkbox"/> Division facts                | <input type="checkbox"/> Understanding decimals         |

TERM 1: Weeks 4–6

Lesson name	Learning intention and success criteria	Differentiating independent practice	Annotations, other resources, teacher sign off
Multiply and divide integers	<b>Learning intention:</b> To be able to multiply and divide integers		
	<b>Success criteria:</b> SC 1: I can multiply two integers. SC 2: I can divide two integers.		
Solve problems by multiplying and dividing integers	<b>Learning intention:</b> To be able to solve problems by multiplying and dividing integers		
	<b>Success criteria:</b> SC 1: I can determine the sign of problems involving multiple multiplications or divisions. SC 2: I can multiply and divide integers in word problems.		
Use the four operations with integers	<b>Learning intention:</b> To be able to use the four operations with integers		
	<b>Success criteria:</b> SC 1: I can use any of the four operations to solve problems. SC 2: I can solve problems with brackets.		

	<p>Multiply and divide rational numbers</p>	<p><b>Learning intention:</b> To be able to multiply and divide rational numbers</p>			
		<p><b>Success criteria:</b> SC 1: I can multiply and divide decimals.</p>			
		<p>SC 2: I can multiply and divide fractions.</p>			
	<p>Apply all four operations with integers, fractions and decimals</p>	<p><b>Learning intention:</b> To be able to apply all four operations with integers, fractions and decimals</p>			
		<p><b>Success criteria:</b> SC 1: I can use all four operations to simplify and calculate expressions containing rational numbers.</p>			
		<p>SC 2: I can solve word problems involving rational numbers.</p>			

Uncorrected proof – sample only

## TOPIC 3: RATIONAL AND IRRATIONAL NUMBERS

**Content descriptions:**

VC2M8N01 recognise irrational numbers in applied contexts, including  $\pi$  and numbers that develop from the square root of positive real numbers that are not perfect squares, and recognise that irrational numbers cannot develop from the division of integer values by natural numbers

VC2M8N03 convert between fractions and terminating or recurring decimals, using digital tools as appropriate

*The Victorian Curriculum F-10 content elements are © VCAA*

**Pearson Diagnostic quizzes**

Understanding decimals

TERM 1: Weeks 7–8

Lesson name	Learning intention and success criteria	Differentiating independent practice	Annotations, other resources, teacher sign off
Identify and use irrational numbers	<p><b>Learning intention:</b> To understand and create equivalent fractions</p> <p><b>Success criteria:</b> SC 1: I can use a model to create equivalent fractions. SC 2: I can write a string of equivalent fractions.</p>		
Identify the golden ratio and make the connection between the circumference and diameter of any circle	<p><b>Learning intention:</b> To be able to identify the golden ratio and make the connection between the circumference and diameter of any circle</p> <p><b>Success criteria:</b> SC 1: I can identify the golden ratio in various real-world contexts. SC 2: I can make the connection between the circumference and diameter of any circle.</p>		
Identify and use terminating, recurring and non-recurring decimals	<p><b>Learning intention:</b> To be able to identify and use terminating, recurring and non-recurring decimals</p> <p><b>Success criteria:</b> SC 1: I can recognise terminating, recurring and non-recurring decimals and choose appropriate representations for each. SC 2: I can convert recurring decimals to exact fractional form.</p>		

## TOPIC 4: PERCENTAGE INCREASE AND DECREASE

**Content descriptions:**

VC2M8N05 solve problems involving the use of percentages, including percentage increases and decreases and percentage error, with and without digital tools

VC2M8N06 use mathematical modelling to solve practical problems involving rational numbers and percentages, including financial contexts involving profit and loss; formulate problems, choosing efficient mental and written calculation strategies and using digital tools where appropriate; interpret and communicate solutions in terms of the context, reviewing the appropriateness of the model

*The Victorian Curriculum F-10 content elements are © VCAA*

**Pearson Diagnostic quizzes**

- |   |  |
|---|--|
| <input type="checkbox"/> Percentage estimation    | <input type="checkbox"/> Percentage strategies |
| <input type="checkbox"/> Percentage problem types | <input type="checkbox"/> Percentage change     |

TERM 1: Week 9

Lesson name	Learning intention and success criteria	Differentiating independent practice	Annotations, other resources, teacher sign off
Understand percentage increase and decrease	<p><b>Learning intention:</b> To understand percentage increase and decrease</p> <p><b>Success criteria:</b> SC 1: I can calculate the percentage increase or decrease between different values.</p>		
	<p>SC 2: I can calculate the amount of increase or decrease given a value and a percentage change.</p>		
	<p>SC 3: I can model situations and solve problems involving rational numbers and percentages.</p>		
Understand percentage changes in realistic situations	<p><b>Learning intention:</b> To understand percentage changes in realistic situations</p> <p><b>Success criteria:</b> SC 1: I can explain and calculate mark-ups, discounts and GST.</p>		
	<p>SC 2: I can determine changes as percentage increase or decrease in realistic situations.</p>		
	<p>SC 3: I can explain income tax and calculate taxation.</p>		

# TERM 2

## TOPIC 5: ALGEBRA (EXPAND, SIMPLIFY AND FACTORISE)

### Content descriptions:

VC2M8A01 create, expand, factorise, rearrange and simplify linear expressions, applying the associative, commutative, identity, distributive and inverse properties

The Victorian Curriculum F-10 content elements are © VCAA

### Pearson Diagnostic quizzes

- |   |   |
|---|---|
| <input type="checkbox"/> Values for letters   | <input type="checkbox"/> Formulating algebraic expressions      |
| <input type="checkbox"/> Letters for numbers or objects   | <input type="checkbox"/> Writing expressions using area rules   |
| <input type="checkbox"/> Writing expressions involving multiplication, addition and subtraction | <input type="checkbox"/> Expanding brackets using an area model |

TERM 2: Weeks 1–2

Lesson name	Learning intention and success criteria	Differentiating independent practice	Annotations, other resources, teacher sign off
Use the distributive law to expand simple algebraic expressions	<b>Learning intention:</b> To be able to use the distributive law to expand simple algebraic expressions		
	<b>Success criteria:</b> SC 1: I can describe and illustrate the distributive law using the area model. SC 2: I can use the distributive law to expand algebraic expressions.		
Factorise simple algebraic expressions	<b>Learning intention:</b> To be able to factorise simple algebraic expressions		
	<b>Success criteria:</b> SC 1: I can factorise algebraic expressions by finding a numerical common factor. SC 2: I can factorise expressions by finding an algebraic common factor. SC 3: I can factorise expressions in which the highest common factor is made up of a number and a variable.		
Simplify algebraic expressions involving multiple operations	<b>Learning intention:</b> To be able to simplify algebraic expressions involving multiple operations		
	<b>Success criteria:</b> SC 1: I can simplify algebraic expressions involving addition, subtraction and multiplication. SC 2: I can simplify algebraic expressions involving division and fractions.		

## TOPIC 6: LINEAR GRAPHS

**Content descriptions:**

VC2M8A02 graph linear relations on the Cartesian plane using digital tools where appropriate; solve linear equations and one-variable inequalities using graphical and algebraic techniques; verify solutions by substitution

VC2M8A03 use mathematical modelling to solve applied problems involving linear relations, including financial contexts involving profit and loss; formulate problems with linear functions, and choose a representation; interpret and communicate solutions in terms of the context, and review the appropriateness of the model

*The Victorian Curriculum F-10 content elements are © VCAA*

**Pearson Diagnostic quizzes**

- |   |  |
|---|--|
| <input type="checkbox"/> Plotting coordinates             | <input type="checkbox"/> Grid references and coordinates |
| <input type="checkbox"/> Representing linear functions    | <input type="checkbox"/> Interpreting line graphs        |
| <input type="checkbox"/> Interpreting gradients of graphs | <input type="checkbox"/> Solving linear equations        |
| <input type="checkbox"/> Reading scales                   | <input type="checkbox"/> Writing linear equations        |

TERM 2: Weeks 3–5

Lesson name	Learning intention and success criteria	Differentiating independent practice	Annotations, other resources, teacher sign off
Plot and identify a linear relationship using a set of points	<p><b>Learning intention:</b> To be able to plot and identify a linear relationship using a set of points</p> <p><b>Success criteria:</b></p> <p>SC 1: I can use two points to plot a linear relationship.</p> <p>SC 2: I can use a linear relationship to generate coordinate pairs.</p> <p>SC 3: I can draw a graph of a linear relationship from a practical context.</p>		
Graph linear relationships with only one axis intercept	<p><b>Learning intention:</b> To be able to determine the proportion of a quantity</p> <p><b>Success criteria:</b></p> <p>SC 1: I can recognise and draw vertical and horizontal graphs.</p> <p>SC 2: I can recognise and draw graphs which pass through the origin.</p>		
Investigate linear graphs using	<p><b>Learning intention:</b> To investigate linear graphs using technology</p> <p><b>Success criteria:</b></p>		

	technology	<p>SC 1: I can determine the rule for a linear relationship using technology.</p> <p>SC 2: I understand the connection between the y-intercept and the value of c in <math>y = mx + b</math>.</p> <p>SC 3: I understand the connection between linear relationships in the form <math>y = mx + b</math> and the slope of the line.</p>			
	Determine the rule for a linear relationship or pattern	<p><b>Learning intention:</b> To be able to determine the rule for a linear relationship or pattern</p> <p><b>Success criteria:</b></p> <p>SC 1: I can determine the rule for a linear relationship using two points.</p> <p>SC 2: I can determine the rule for a linear relationship where the y-intercept is known.</p>			
	Solve linear equations graphically	<p><b>Learning intention:</b> To be able to solve linear equations graphically</p> <p><b>Success criteria:</b></p>			
		<p>SC 1: I can solve linear equations of the type <math>ax + b = c</math> using a pair of linear graphs.</p>			
		<p>SC 2: I can solve linear equations of the type <math>ax + b = cx + d</math> using a pair of linear graphs.</p> <p>SC 3: I can use digital tools to investigate integer solutions to <math>ax + by = c</math>.</p>			

## TOPIC 7: LINEAR INEQUALITIES

**Content descriptions:**

VC2M8A02 graph linear relations on the Cartesian plane using digital tools where appropriate; solve linear equations and one-variable inequalities using graphical and algebraic techniques; verify solutions by substitution

VC2M8A03 use mathematical modelling to solve applied problems involving linear relations, including financial contexts involving profit and loss; formulate problems with linear functions, and choose a representation; interpret and communicate solutions in terms of the context, and review the appropriateness of the model

*The Victorian Curriculum F-10 content elements are © VCAA*

**Pearson Diagnostic quizzes**

- |  |   |
|--|---|
| <input type="checkbox"/> Grid references and coordinates | <input type="checkbox"/> Solving linear equations |
| <input type="checkbox"/> Interpreting line graphs        | <input type="checkbox"/> Writing linear equations |

TERM 2: Weeks 6–7

Lesson name	Learning intention and success criteria	Differentiating independent practice	Annotations, other resources, teacher sign off
Graph inequalities on number lines	<b>Learning intention:</b> To be able to graph inequalities on number lines <b>Success criteria:</b> SC 1: I can graph inequalities with non-inclusive endpoints on number lines. SC 2: I can graph inequalities where the endpoint is included on number lines. SC 3: I can graph an interval on a number line.		
Graph linear inequalities on the Cartesian plane	<b>Learning intention:</b> To be able to graph linear inequalities on the Cartesian plane <b>Success criteria:</b> SC 1: I can graph inequalities involving single variables on the Cartesian plane. SC 2: I can graph intervals involving single variables on the Cartesian plane. SC 3: I can graph inequalities involving two variables on the Cartesian plane.		
Solve linear inequalities	<b>Learning intention:</b> To be able to solve linear inequalities <b>Success criteria:</b> SC 1: I can solve linear inequalities. SC 2: I can solve linear inequalities where the symbol must be reversed.		

## TOPIC 8: PERIMETER AREA AND VOLUME

**Content descriptions:**

VC2M8M01 solve problems involving the area and perimeter of irregular and composite shapes using appropriate units

VC2M8M02 solve problems involving the volume and capacity of right prisms using appropriate units

*The Victorian Curriculum F-10 content elements are © VCAA*

**Pearson Diagnostic quizzes**

- |   |  |
|---|--|
| <input type="checkbox"/> Estimation (not counting)        | <input type="checkbox"/> Volume using litres                     |
| <input type="checkbox"/> Estimation of length             | <input type="checkbox"/> Volume using cubic measures             |
| <input type="checkbox"/> Length and area (basic concepts) | <input type="checkbox"/> Labelling base and height of a triangle |

TERM 2: Weeks 8–10

Lesson name	Learning intention and success criteria	Differentiating independent practice	Annotations, other resources, teacher sign off
Estimate and convert units of length	<b>Learning intention:</b> To be able to estimate and convert units of length		
	<b>Success criteria:</b> SC 1: I can estimate lengths by comparing with known lengths.		
	SC 2: I can convert between units of length using metric prefixes.		
Calculate the perimeter of quadrilaterals	<b>Learning intention:</b> To be able to calculate the perimeter of quadrilaterals		
	<b>Success criteria:</b> SC 1: I can calculate the perimeter of a rectangle.		
	SC 2: I can calculate the perimeter of a quadrilateral. SC 3: I can extend my understanding of perimeter to a polygon.		
Determine the unknown side lengths from a given perimeter	<b>Learning intention:</b> To be able to determine the unknown side lengths from a given perimeter		
	<b>Success criteria:</b> SC 1: I can determine unknown side lengths in a rectangle and other quadrilaterals given the perimeter.		
	SC 2: I can determine unknown side lengths in any polygon given the perimeter.		

<p>Calculate the area of a trapezium</p>	<p><b>Learning intention:</b> To be able to calculate the area of a trapezium</p> <p><b>Success criteria:</b>            SC 1: I can determine the area of a trapezium by drawing a rectangle with the same area.            SC 2: I can calculate the area of a trapezium using a formula.</p>	<p>Blue Green Orange</p>	
<p>Calculate the area of kites and rhombuses</p>	<p><b>Learning intention:</b> To be able to calculate the area of kites and rhombuses</p> <p><b>Success criteria:</b>            SC 1: I can determine the area of a kite or rhombus from the areas of rectangles and triangles.            SC 2: I can calculate the area of a kite or rhombus using a formula.</p>	<p>Blue Green Orange</p>	
<p>Calculate the area of composite shapes</p>	<p><b>Learning intention:</b> To be able to calculate the area of composite shapes</p> <p><b>Success criteria:</b>            SC 1: I can calculate the area of composite shapes.</p>	<p>Blue Green Orange</p>	
<p>Approximate the perimeter and area of irregular shapes</p>	<p><b>Learning intention:</b> To be able to approximate the perimeter and area of irregular shapes</p> <p><b>Success criteria:</b>            SC 1: I can approximate the perimeter of irregular shapes.            SC 2: I can approximate the area of irregular shapes.            SC 3: I can solve practical problems involving irregular shapes.</p>	<p>Blue Green Orange</p>	
<p>Understand the connection between volume and capacity</p>	<p><b>Learning intention:</b> To understand the connection between volume and capacity</p> <p><b>Success criteria:</b>            SC 1: I can convert between metric units of volume.            SC 2: I can calculate volume to determine capacity of prism-shaped containers.            SC 3: I can solve a variety of practical problems involving the volumes and capacities of prisms.</p>	<p>Blue Green Orange</p>	

# TERM 3

## TOPIC 9: CIRCLES AND SECTORS

**Content descriptions:**

VC2M8M0 solve problems involving the circumference and area of a circle using formulas and appropriate units

*The Victorian Curriculum F-10 content elements are © VCAA*

**Pearson Diagnostic quizzes**

Estimation of length

Length and area (basic concepts)

TERM 3: Weeks 1–2

Lesson name	Learning intention and success criteria	Differentiating independent practice	Annotations, other resources, teacher sign off
Determine the area of a circle	<b>Learning intention:</b> To be able to determine the area of a circle		
	<b>Success criteria:</b> SC 1: I can establish the formula for the area of a circle using approximations. SC 2: I can calculate the area of a circle.		
Determine the area of a sector using common fractions	<b>Learning intention:</b> To be able to Determine the area of a sector using common fractions		
	<b>Success criteria:</b> SC 1: I can determine the area of a sector using common fractions.		
Determine sector area and arc length	<b>Learning intention:</b> To be able to determine sector area and arc length		
	<b>Success criteria:</b> SC 1: I can determine the area of a sector of a circle of any degree. SC 2: I can determine the arc length of a sector.		
Determine the area of composite shapes involving circles	<b>Learning intention:</b> To be able to determine the area of composite shapes involving circles		
	<b>Success criteria:</b> SC 1: I can determine the area of composite shapes involving circles.		
Solve problems involving circle measurements	<b>Learning intention:</b> To be able to solve problems involving circle measurements		
	<b>Success criteria:</b> SC 1: I can solve practical problems involving circle measurements.		

## TOPIC 10: TIME

**Content descriptions:**

VC2M8M04 solve problems involving duration, including using 12- and 24-hour time across multiple time zones

*The Victorian Curriculum F-10 content elements are © VCAA*

**Pearson Diagnostic quizzes**

N/A

TERM 3: Weeks 3–4

Lesson name	Learning intention and success criteria	Differentiating independent practice	Annotations, other resources, teacher sign off
Understand 24-hour time	<b>Learning intention:</b> To understand 24-hour time <b>Success criteria:</b> SC 1: I can convert 12-hour time to 24-hour time.		
	SC 2: I can convert 24-hour time to 12-hour time.		
	SC 3: I can calculate duration with 12-hour and 24-hour time.		
Understand the effect of daylight savings and longitude on local time	<b>Learning intention:</b> To understand the effect of daylight savings and longitude on local time <b>Success criteria:</b> SC 1: I can determine the effect of DST on local time.		
	SC 2: I can determine the effect of longitude on local time.		
Understand and work with different time zones	<b>Learning intention:</b> To understand and work with different time zones <b>Success criteria:</b> SC 1: I can determine local time throughout Australia.		
	SC 2: I can determine local time around the world.		
	SC 3: I can make travel plans across different time zones.		

## TOPIC 11: RATES

**Content descriptions:**

VC2M8M05 recognise and use rates to solve problems involving the comparison of 2 related quantities of different units of measure

*The Victorian Curriculum F-10 content elements are © VCAA*

**Pearson Diagnostic quizzes**

- |   |   |
|---|---|
| <input type="checkbox"/> Comparing ratios             | <input type="checkbox"/> Reading scales           |
| <input type="checkbox"/> Calculating with proportions | <input type="checkbox"/> Interpreting line graphs |

TERM 3: Weeks 5–6

Lesson name	Learning intention and success criteria	Differentiating independent practice	Annotations, other resources, teacher sign off
Understand and apply rates	<p><b>Learning intention:</b> To understand and apply rates</p> <p><b>Success criteria:</b>                      SC 1: I can understand the difference between a rate and a ratio and convert a speed to a related rate.                      SC 2: I can use rates to determine unknown values.</p>		
Apply rates to financial situations	<p><b>Learning intention:</b> To be able to apply rates to financial situations</p> <p><b>Success criteria:</b>                      SC 1: I can apply rates to earning and spending money.                      SC 2: I can understand and apply simple interest.</p>		
Apply rates to tax calculations	<p><b>Learning intention:</b> To be able to apply rates to tax calculations</p> <p><b>Success criteria:</b>                      SC 1: I can calculate tax payable from taxation tables.                      SC 2: I can solve problems involving taxation.</p>		

## TOPIC 12: PYTHAGORAS' THEOREM IN 2D

**Content descriptions:**

VC2M8M06 use Pythagoras' theorem to solve problems involving the side lengths of right-angled triangles

*The Victorian Curriculum F-10 content elements are © VCAA*

**Pearson Diagnostic quizzes**

- Labelling base and height of a triangle
- Readiness to learn about Pythagoras theorem

TERM 3: Weeks 7–9

Lesson name	Learning intention and success criteria	Differentiating independent practice	Annotations, other resources, teacher sign off
Measure the side lengths of a right-angled triangle	<p><b>Learning intention:</b> To be able to measure the side lengths of a right-angled triangle</p> <p><b>Success criteria:</b></p> <p>SC 1: I can identify the hypotenuse in a right-angled triangle.</p> <p>SC 2: I can construct and measure the side lengths of a right-angled triangle.</p>		
Understand and use Pythagoras' theorem to identify right-angled triangles	<p><b>Learning intention:</b> To understand and use Pythagoras' theorem to identify right-angled triangles</p> <p><b>Success criteria:</b></p> <p>SC 1: I can establish the relationship between the side lengths in a right-angled triangle.</p> <p>SC 2: I can identify and use Pythagorean triples.</p> <p>SC 3: I can recognise the relationship between the squares of lengths of sides for different types of triangles.</p>		
Compare different applications, demonstrations and proofs of Pythagoras' theorem	<p><b>Learning intention:</b> To be able to compare different applications, demonstrations and proofs of Pythagoras' theorem</p> <p><b>Success criteria:</b></p> <p>SC 1: I can demonstrate and prove Pythagoras' theorem using a square shape.</p> <p>SC 2: I can use Pythagoras' theorem for similar shapes on the sides of right-angled triangles.</p>		

<p>Use Pythagoras' theorem to determine the length of the hypotenuse</p>	<p><b>Learning intention:</b> To be able to use Pythagoras' theorem to determine the length of the hypotenuse</p>		
	<p><b>Success criteria:</b></p> <p>SC 1: I can use Pythagoras' theorem to determine the length of a hypotenuse.</p>		
	<p>SC 2: I can solve problems involving determining the length of a hypotenuse.</p>		
	<p><b>Learning intention:</b> To be able to use Pythagoras' theorem to determine the length of a shorter side in a right-angled triangle</p>		
	<p><b>Success criteria:</b></p> <p>SC 1: I can rearrange Pythagoras' theorem to determine the length of a shorter side of a right-angled triangle.</p>		
	<p>SC 2: I can solve problems using Pythagoras' theorem.</p>		

Uncorrected proof – sample only

## TOPIC 13: RATIOS TO SOLVE PROBLEMS

**Content descriptions:**

VC2M8M07 use mathematical modelling to solve practical problems involving ratios and rates, including distance-time problems for travel at a constant speed and financial contexts; formulate problems; interpret and communicate solutions in terms of the situation, reviewing the appropriateness of the model

*The Victorian Curriculum F-10 content elements are © VCAA*

**Pearson Diagnostic quizzes**

- Comparing ratios
- Calculating with proportions

TERM 3: Week 10

Lesson name	Learning intention and success criteria	Differentiating independent practice	Annotations, other resources, teacher sign off
Solve problems involving proportional reasoning	<b>Learning intention:</b> To be able to solve problems involving proportional reasoning		
	<b>Success criteria:</b> SC 1: I can use ratio to solve practical problems. SC 2: I can work with scales on maps and plans. SC 3: I can calculate magnification factors.		
Apply ratios to currency exchange	<b>Learning intention:</b> To be able to apply ratios to currency exchange		
	<b>Success criteria:</b> SC 1: I can determine the value of amounts of money in foreign currencies. SC 2: I can manage a budget involving foreign currency.		

# TERM 4

## TOPIC 14: TRIANGLES AND QUADRILATERALS (SIMILARITY AND CONGRUENCE)

**Content descriptions:**

VC2M8SP01 identify the conditions for congruence and similarity of triangles and explain the conditions for other sets of common shapes to be congruent or similar, including those formed by transformations

VC2M8SP02 establish properties of quadrilaterals using congruent triangles and angle properties, and solve related problems explaining reasoning

*The Victorian Curriculum F-10 content elements are © VCAA*

**Pearson Diagnostic quizzes**

Labelling base and height of a triangle

Congruence and similarity

TERM 4: Week 1–3

Lesson name	Learning intention and success criteria	Differentiating independent practice	Annotations, other resources, teacher sign off	
Apply transformations to shapes in the plane	<p><b>Learning intention:</b> To be able to apply transformations to shapes in the plane</p> <p><b>Success criteria:</b></p> <p>SC 1: I can describe and apply a translation.</p> <p>SC 2: I can apply a reflection and draw lines of symmetry.</p> <p>SC 3: I can apply a rotation and determine the order of rotational symmetry.</p>	<div style="background-color: #0070C0; height: 20px; width: 100%;"></div> <div style="background-color: #709238; height: 20px; width: 100%;"></div> <div style="background-color: #FFA500; height: 20px; width: 100%;"></div>		
	Prove congruence in pairs of triangles	<p><b>Learning intention:</b> To be able to prove congruence in pairs of triangles</p> <p><b>Success criteria:</b></p> <p>SC 1: I can draw triangles given side lengths and angles.</p> <p>SC 2: I can use each of the four tests for congruent triangles.</p> <p>SC 3: I can prove congruence in pairs of triangles to determine unknown side lengths or angles.</p>	<div style="background-color: #0070C0; height: 20px; width: 100%;"></div> <div style="background-color: #709238; height: 20px; width: 100%;"></div> <div style="background-color: #FFA500; height: 20px; width: 100%;"></div>	
		Explore the properties of quadrilaterals using	<p><b>Learning intention:</b> To explore the properties of quadrilaterals using congruent triangles</p> <p><b>Success criteria:</b></p>	<div style="background-color: #0070C0; height: 20px; width: 100%;"></div>

congruent triangles	SC 1: I can establish properties of quadrilaterals using congruent triangles.		
	SC 2: I can prove congruence in pairs of triangles to determine unknown side lengths or angles in symmetrical quadrilaterals.		
	SC 3: I can draw diagrams identifying the main properties of quadrilaterals including side lengths, parallel sides, angles, diagonals and symmetry.		
Determine and apply scale factor and angle properties in similar shapes	<b>Learning intention:</b> To be able to determine and apply scale factor and angle properties in similar shapes		
	<b>Success criteria:</b> SC 1: I can draw the result of an enlargement by a given scale factor.		
	SC 2: I can determine the scale factor used to enlarge a figure. SC 3: I can determine lengths and angles in similar shapes.		
Prove similarity in pairs of triangles	<b>Learning intention:</b> To be able to prove similarity in pairs of triangles		
	<b>Success criteria:</b> SC 1: I can use each of the four tests for similar triangles.		
	SC 2: I can apply logical reasoning to determine side lengths and angles.		

## TOPIC 15: VISUALISING 3D

**Content descriptions:**

VC2M8SP03 describe in different ways the position and location of three-dimensional objects in 3 dimensions, including using a three-dimensional Cartesian coordinate system with the use of dynamic geometry software or other digital tools

*The Victorian Curriculum F-10 content elements are © VCAA*

**Pearson Diagnostic quizzes**

N/A

TERM 4: Week 4

Lesson name	Learning intention and success criteria	Differentiating independent practice	Annotations, other resources, teacher sign off
Locate and describe the position of objects in 3D space	<b>Learning intention:</b> To be able to locate and describe the position of objects in 3D space  <b>Success criteria:</b> SC 1: I can locate objects in space using three dimensions.		
Use the 3D coordinate system	<b>Learning intention:</b> To be able to use the 3D coordinate system  <b>Success criteria:</b> SC 1: I can describe and compare 2D and 3D coordinate systems.		

## TOPIC 16: COLLECTING AND ANALYSING DATA

### Content descriptions:

VC2M8ST01 distinguish between a population and a sample, and investigate techniques for data collection including census, sampling, experiment and observation, and explain the practicalities and implications of obtaining data through these techniques

VC2M8ST02 analyse and report on the distribution of data from primary and secondary sources using random and non-random sampling techniques to select and study samples

VC2M8ST03 compare variations in distributions and proportions obtained from random samples of the same size drawn from a population and recognise the effect of sample size on this variation

The Victorian Curriculum F-10 content elements are © VCAA

### Pearson Diagnostic quizzes

- |   |  |
|---|--|
| <input type="checkbox"/> Interpreting pictographs | <input type="checkbox"/> Choosing appropriate graphs         |
| <input type="checkbox"/> Interpreting bar graphs  | <input type="checkbox"/> Arithmetic average (mean)           |
| <input type="checkbox"/> Interpreting line graphs | <input type="checkbox"/> Understanding mean, median and mode |

TERM 4: Weeks 5–6

Lesson name	Learning intention and success criteria	Differentiating independent practice	Annotations, other resources, teacher sign off
Compare sampling methods	<b>Learning intention:</b> To be able to compare sampling methods		
	<b>Success criteria:</b> SC 1: I can identify situations where a census or sample has been used to collect data.		
	SC 2: I can collect samples using a variety of techniques, including random and non-random sampling. SC 3: I can recognise where bias may occur in a sampling method.		
Understand sampling techniques and data sources	<b>Learning intention:</b> To understand sampling techniques and data sources		
	<b>Success criteria:</b> SC 1: I can distinguish between different sampling methods.		
	SC 2: I can explain the benefits and limitations of various sampling techniques. SC 3: I can explain the difference between primary and secondary data.		
	SC 4: I can understand and explain various statistical terms.		

Understand and interpret statistics from different samples from the same population	<p><b>Learning intention:</b> To understand and interpret statistics from different samples from the same population</p> <p><b>Success criteria:</b>            SC 1: I can compare variations obtained from random samples drawn from the same population.            SC 2: I can explain the effect of individual values, including outliers, on statistical values.            SC 3: I can conduct a simulation using a digital tool.</p>		
Plan and conduct a statistical investigation	<p><b>Learning intention:</b> To be able to plan and conduct a statistical investigation</p> <p><b>Success criteria:</b>            SC 1: I can recognise ethical and fair methods in an investigation.            SC 2: I can draw conclusions from the data collected.            SC 3: I can explain why sampling is necessary in many situations yet still allows for reliable inferences about a population.</p>		

Uncorrected proof – sample only

## TOPIC 17: PROBABILITY (VENN DIAGRAMS AND TWO-WAY TABLES)

**Content descriptions:**

VC2M8P01 recognise that complementary events have a combined probability of one; use this relationship to calculate probabilities in applied contexts

VC2M8P02 determine all possible combinations for 2 events, using two-way tables, tree diagrams and Venn diagrams, and use these to determine probabilities of specific events in practical situations







*The Victorian Curriculum F-10 content elements are © VCAA*

**Pearson Diagnostic quizzes**

- Probability (simple outcome spaces)
- Long run probability

TERM 4: Weeks 7–9

Lesson name	Learning intention and success criteria	Differentiating independent practice	Annotations, other resources, teacher sign off
Understand complementary events	<p><b>Learning intention:</b> To understand complementary events</p> <p><b>Success criteria:</b></p> <p>SC 1: I can identify events and complementary events.</p> <p>SC 2: I can solve problems by knowing that the probabilities of an event and its complement add to 1.</p> <p>SC 3: I can use digital tools to conduct probability simulations to determine if long run events are complementary.</p>		
Draw and understand Venn diagrams	<p><b>Learning intention:</b> To be able draw and understand Venn diagrams</p> <p><b>Success criteria:</b></p> <p>SC 1: I can represent data using set notation and incorporate data into a Venn diagram.</p> <p>SC 2: I can draw Venn diagrams showing sets, complementary sets, union and intersection of sets, and the universal set.</p> <p>SC 3: I can use given data to calculate probabilities from a Venn diagram.</p>		
Draw and understand two-	<p><b>Learning intention:</b> To be able to draw and understand two-way tables</p>		

way tables	<p><b>Success criteria:</b></p> <p>SC 1: I can interpret the data in a two-way table.</p> <p>SC 2: I can create a two-way table with probabilities.</p> <p>SC 3: I can use given data to calculate missing probabilities in a two-way table.</p>			
Recognise and understand mutually exclusive and non-mutually exclusive events	<p><b>Learning intention:</b> To be able to recognise and understand mutually exclusive and non-mutually exclusive events</p>			
	<p><b>Success criteria:</b></p> <p>SC 1: I can recognise mutually exclusive and non-mutually exclusive events.</p>			
	<p>SC 2: I can calculate the probability of mutually exclusive events.</p> <p>SC 3: I can use Venn diagrams and two-way tables to demonstrate the difference between mutually exclusive and non-mutually exclusive events.</p>			
Use Venn diagrams and two-way tables to solve problems	<p><b>Learning intention:</b> To be able to use Venn diagrams and two-way tables to solve problems</p>			
	<p><b>Success criteria:</b></p> <p>SC 1: I can use the terminology 'at least', 'exclusive or', 'inclusive or' and 'and'.</p>			
	<p>SC 2: I can calculate probabilities for events satisfying 'and', 'or' and 'not'.</p>			

## References

---

The Victorian Curriculum F-10 content elements are © VCAA, reproduced by permission. The VCAA does not endorse or make any warranties regarding this resource. The Victorian Curriculum F-10 and related content can be accessed directly at the VCAA website.

Uncorrected proof – sample only